

FLENDER COUPLINGS

N-EUPEX

Operating Instructions 3102en
Edition 01/2019

D, E, M



FLENDER COUPLINGS

N-EUPEX 3102en

Operating Instructions

D, E, M

<u>Introduction</u>	1
<u>Safety instructions</u>	2
<u>Description</u>	3
<u>Application planning</u>	4
<u>Assembly</u>	5
<u>Commissioning</u>	6
<u>Operation</u>	7
<u>Servicing</u>	8
<u>Service and support</u>	9
<u>Disposal</u>	10
<u>Spare parts</u>	11
<u>Technical data</u>	A
<u>Quality documents</u>	B

Legal information

Warning notice system

This manual contains notices you have to observe in order to ensure your personal safety, as well as to prevent damage to property. The notices referring to your personal safety are highlighted in the manual by a safety alert symbol, notices referring only to property damage have no safety alert symbol. These notices shown below are graded according to the degree of danger.

 DANGER
indicates that death or severe personal injury will result if proper precautions are not taken.

 WARNING
indicates that death or severe personal injury may result if proper precautions are not taken.

 CAUTION
indicates that minor personal injury can result if proper precautions are not taken.

NOTICE
indicates that property damage can result if proper precautions are not taken.

If more than one degree of danger is present, the warning notice representing the highest degree of danger will be used. A notice warning of injury to persons with a safety alert symbol may also include a warning relating to property damage.

Qualified Personnel

The product/system described in this documentation may be operated only by **personnel qualified** for the specific task in accordance with the relevant documentation, in particular its warning notices and safety instructions. Qualified personnel are those who, based on their training and experience, are capable of identifying risks and avoiding potential hazards when working with these products/systems.

Proper use of Flender products

Note the following:

 WARNING
Flender products may only be used for the applications described in the catalog and in the relevant technical documentation. If products and components from other manufacturers are used, these must be recommended or approved by Flender. Proper transport, storage, installation, assembly, commissioning, operation and maintenance are required to ensure that the products operate safely and without any problems. The permissible ambient conditions must be complied with. The information in the relevant documentation must be observed.

Trademarks

All names identified by ® are registered trademarks of Flender GmbH. The remaining trademarks in this publication may be trademarks whose use by third parties for their own purposes could violate the rights of the owner.

Disclaimer of Liability

We have reviewed the contents of this publication to ensure consistency with the hardware and software described. Since variance cannot be precluded entirely, we cannot guarantee full consistency. However, the information in this publication is reviewed regularly and any necessary corrections are included in subsequent editions.

Table of contents

1	Introduction	9
1.1	About these instructions.....	9
1.2	Text attributes.....	9
1.3	Copyright.....	9
2	Safety instructions	11
2.1	General information.....	11
2.2	Intended use.....	13
2.3	Safety instructions for a coupling for use in potentially explosive atmospheres.....	13
2.3.1	Marking.....	13
2.3.2	Conditions of use.....	14
2.4	General warning notices.....	15
3	Description	17
4	Application planning	19
4.1	Transport of the coupling.....	19
4.2	Storage of the coupling.....	19
5	Assembly	21
5.1	Preparatory work.....	21
5.1.1	Milling the parallel keyway.....	22
5.1.2	Milling the parallel keyway.....	24
5.1.3	Machining an axial locking mechanism.....	24
5.1.4	Balancing the coupling.....	28
5.2	Assembling the coupling.....	29
5.3	Aligning the coupling.....	30
5.3.1	Purpose of alignment.....	30
5.3.2	Possible misalignment.....	31
5.3.2.1	Axial misalignment.....	31
5.3.2.2	Angular misalignment.....	31
5.3.2.3	Radial misalignment.....	32
6	Commissioning	33
7	Operation	35
7.1	Normal operation of the coupling.....	35
7.2	Faults - causes and rectification.....	35
7.2.1	Procedure in the event of malfunctions.....	35
7.2.2	Identifying the fault cause.....	35
7.2.2.1	Possible faults.....	36
7.2.2.2	Possible causes.....	37

7.2.3	Correcting faults	38
7.2.3.1	Replacing wearing parts.....	38
7.2.3.2	Correcting the changed alignment	39
8	Servicing.....	41
8.1	Maintenance intervals	41
8.2	Maximum permissible torsional backlash.....	42
8.3	Replacing wearing parts.....	43
8.4	Removing the coupling.....	44
9	Service and support.....	45
10	Disposal.....	47
11	Spare parts	49
11.1	Ordering spare parts	49
11.2	Spare parts drawing and spare parts list.....	50
11.2.1	Type D.....	50
11.2.2	Type E.....	51
11.2.3	Type M	51
A	Technical data	53
A.1	Speeds, geometry data and weights	53
A.1.1	Type D.....	53
A.1.2	Type E.....	55
A.1.3	Type M	56
A.2	Shaft misalignment values during operation	57
A.3	Tightening torques and widths A/F.....	58
A.4	Tightening procedure	59
A.5	Flexible elements (12).....	59
A.5.1	Use and storage of flexible elements (12).....	59
A.5.2	N-EUPEX flexible elements (12)	60
B	Quality documents.....	61
B.1	EU declaration of conformity	61

Tables

Table 2-1	General warnings	11
Table 2-2	Temperature classes (TX) for explosive atmospheres as a result of gases, vapours or mists.....	15
Table 2-3	Maximum surface temperature (TX) for an explosive atmosphere as a result of dust/air mixtures.....	15
Table 4-1	Types of preservative agents for long-term storage.....	20
Table 5-1	Recommended assigned fits for bores with parallel key connection.....	22
Table 5-2	Position of the parallel keyway	24
Table 5-3	Diameter and axial position of the tapped hole, tightening torque	25

Table 5-4	Position of the tapped hole with respect to the parallel keyway for coupling parts 2 and 4	26
Table 5-5	Position of the tapped hole with respect to the parallel keyway with coupling part 9	26
Table 7-1	Table of faults.....	36
Table 8-1	Maintenance intervals	41
Table 8-2	Maximum permissible torsional backlash for the types D E and M (sizes 68 to 200)	42
Table 8-3	Maximum permissible torsional backlash for the types D, E and M (sizes 225 to 520)	42
Table 11-1	Spare parts list for type D.....	50
Table 11-2	Spare parts list for type E	51
Table 11-3	Spare parts list for type M	52
Table A-1	Speeds, geometry data and weights of type D.....	54
Table A-2	Speeds, geometry data and weights of type E.....	55
Table A-3	Speeds, geometry data and weights of type M	56
Table A-4	Maximum permissible shaft misalignment values during operation	57
Table A-5	Tightening torques for part 13 of type D.....	58
Table A-6	Tightening procedure	59
Table A-7	N-EUPEX flexible elements.....	60

Figures

Figure 3-1	Type D.....	17
Figure 3-2	Type E.....	18
Figure 3-3	Type M	18
Figure 4-1	Transport symbols.....	19
Figure 5-1	Tolerances for finished bore.....	23
Figure 5-2	Diameter and axial position of the tapped hole in the hub	25
Figure 5-3	Position of the balancing bore for single-plane balancing	28
Figure 5-4	Position of the balancing bore for two-plane balancing.....	28
Figure 5-5	Possible misalignment.....	31
Figure 8-1	Markings for calculating the torsional backlash.....	42
Figure 8-2	Tapped jacking hole for loosening coupling part 3 (3).....	43
Figure 11-1	Spare parts drawing for type D.....	50
Figure 11-2	Spare parts drawing for type E.....	51
Figure 11-3	Spare parts drawing for type M	51
Figure A-1	Type D.....	53
Figure A-2	Type E.....	55
Figure A-3	Type M	56

Introduction

1.1 About these instructions

These instructions describe the coupling and provide information about its handling - from assembly to maintenance. Please keep these instructions for later use.

Please read these instructions prior to handling the coupling and follow the information in them.

1.2 Text attributes

The warning notice system is explained on the back of the inner cover. Always follow the safety information and notices in these instructions.

In addition to the warning notices, which have to be observed without fail, you will find the following text attributes in these instructions:

1. Procedural instructions are shown as a numbered list. Always perform the steps in the order given.

- Lists are formatted as bulleted lists.
 - The dash is used for lists at the second level.

(1) Numbers in brackets are part numbers.

Note

A note is an important item of information about the product, the handling of the product or the relevant section of the instructions. The note provides you with help or further suggestions/ ideas.

1.3 Copyright

The copyright for these instructions is held by Flender.

These instructions must not be used wholly or in parts without our authorisation or be given to third parties.

If you have any technical queries, please contact our factory or one of our service outlets (refer to Service and support (Page 45)).

Safety instructions

2.1 General information

Instructions

These instructions are part of the delivery. Always keep these instructions close to the coupling.

Please make sure that every person who is commissioned to work on the coupling has read and understood these instructions prior to handling the coupling and observes all of the points.

Only the knowledge of these instructions can avoid faults on the coupling and ensure fault-free and safe operation. Non-adherence to the instructions can cause product or property damage or personal injury. Flender does not accept any liability for damage or operating failures that are due to non-adherence to these instructions.







State of the art

The coupling described here has been designed in consideration of the latest findings for demanding technical requirements. This coupling is state-of-the-art at the time of printing these instructions.





In the interest of further development, Flender reserves the right to make such changes to the individual components and accessories that increase performance and safety whilst maintaining the essential features.

Symbols

Table 2-1 General warnings

ISO	ANSI	Warning
		Warning - hazardous electrical voltage
		Warning - explosive substances
	---	Warning - entanglement hazard
	---	Warning - hot surfaces
	---	Warning - substances that are harmful to health or are irritants

2.1 General information

ISO	ANSI	Warning
	---	Warning - corrosive substances
	---	Warning - suspended load
	---	Warning - hand injuries
		ATEX certification

Explanation regarding Machinery Directive 2006/42/EC

The couplings described here are “components” in accordance with the Machinery Directive and do not require a declaration of incorporation.

ATEX Directive

The term "ATEX Directive" used in these instructions stands for the harmonisation legislation of the European Union in compliance with the declaration of conformance for equipment and protective systems for correct use in hazardous zones.

Protective clothing

In addition to the generally prescribed personal protective equipment (safety shoes, overalls, helmet, etc.), also wear suitable safety gloves and safety goggles when handling the coupling.

Using the coupling

The relevant work safety and environmental protection regulations must be complied with at all times during transport, assembly, installation, dismantling, operation and maintenance of the coupling.

Only qualified personnel may operate, assemble, maintain and repair the coupling. Information about qualified personnel can be found in the legal notes at the beginning of these instructions.

If lifting gear or load suspension devices are used for transporting, these have to be suitable for the weight of the coupling.

If the coupling has visible damage, it may not be assembled or put into operation.

The coupling may only be operated in a suitable housing or with touch protection according to applicable standards. This also applies to test runs and rotational direction checks.

Work on the coupling

Only carry out work on the coupling when it is not in operation and is not under load.

Secure the drive unit against being switched on accidentally. Attach a notice to the switch stating clearly that work is being carried out on the coupling. Ensure that the entire unit is not under load.

2.2 Intended use

Only use the coupling according to the conditions specified in the service and delivery contract and the technical data in the annex. Deviating operating conditions are considered improper use. The user or owner of the machine or plant is solely liable for any resulting damage.

When using the coupling please specifically observe the following:

- Do not make any modifications to the coupling that go beyond the permissible machining described in these instructions. This also applies to touch protection facilities.
- Only use original spare parts from Flender. Flender only accepts liability for original spare parts from Flender.
Other spare parts are not tested and approved by Flender. Non-approved spare parts may possibly change the design characteristics of the coupling and thus impact active and/or passive safety.
Flender will accept no liability or warranty whatsoever for damage occurring as a result of the use of non-approved spare parts. The same applies to any accessories that were not supplied by Flender.

If you have any queries, please contact our customer service (see Service and support (Page 45)).

2.3 Safety instructions for a coupling for use in potentially explosive atmospheres

2.3.1 Marking

You can find a description of the coupling parts in chapter Description (Page 17).

A coupling designed in accordance with the ATEX Directive has a marking on the coupling parts.

Coupling part 10 without electrically insulating flexible elements

One of the following markings is visible on the outer diameter of coupling part 10:

Version 1:

Flender GmbH



II 2G Ex h IIC T6 ... T4 Gb X

D 46393 Bocholt



II 2D Ex h IIIC T85 °C ... 110 °C Db X

N-EUPEX





<Year of manufacture>



I M2 Ex h Mb X

Coupling part 10 with electrically insulating flexible elements

One of the following markings is visible on the outer diameter of coupling part 10:

Flender GmbH			II 2G Ex h IIB T6 ... T4 Gb X
D 46393 Bocholt			II 2D Ex h IIIC T85 °C ... 110 °C Db X
N-EUPEX	<Year of manufacture>		I M2 Ex h Mb X

Coupling part 2, 4 or 9

Coupling part 2, coupling part 4 or coupling part 9 is stamped with  .

Undrilled or predrilled coupling

A coupling part with Ex marking, the letter "U" and the Flender order number has been delivered undrilled or predrilled.

Note

Undrilled or predrilled coupling with Ex marking

Flender only supplies an undrilled or predrilled coupling with Ex marking on the condition that the customer assumes the responsibility and liability for correct finishing work in a declaration of exemption.

2.3.2 Conditions of use

Note

Note also the material-dependent permissible ambient temperature of the flexible elements (12) in accordance with section N-EUPEX flexible elements (12) (Page 60).

A coupling designed in accordance with the ATEX Directive is suitable for the following conditions of use:

- Equipment group I
 - Category M2
- Equipment group II
 - Category 2 and 3
 - Group of substances G, zone 1 and 2
 - Group of substances D, zone 21 and 22
 - Explosion group IIA, IIB and IIC
 - Explosion group IIA and IIB when electrically insulating flexible elements are used

Conditions of use for products with TX marking

The maximum ambient temperature stated in the following tables applies to the temperature in the direct vicinity of the coupling and the temperature of adjacent components.

1. Gases, vapours or mists

Check the ambient temperature for use of the coupling in the relevant temperature class.

Table 2-2 Temperature classes (TX) for explosive atmospheres as a result of gases, vapours or mists

Max. ambient temperature	Temperature class
80 °C	T4
70 °C	T5
55 °C	T6

2. Dust/air mixtures

Check the ambient temperature.

Table 2-3 Maximum surface temperature (TX) for an explosive atmosphere as a result of dust/air mixtures

Max. ambient temperature	Max. surface temperature
80 °C	110 °C

Notes concerning operation of the coupling in potentially explosive atmospheres

- Only use the coupling underground in mines in potentially explosive atmospheres together with drive motors that can be switched off in the event of the formation of an explosive atmosphere.
- Earth machines that are connected via the coupling with a leakage resistance of less than $10^6 \Omega$.
- If you want to use a coated coupling in potentially explosive atmospheres, please note the requirements concerning the conductivity of the paint and the limitation on the paint layer thickness applied in accordance with EN 80079-36. No build-up of electrostatic charges is to be expected with a paint layer thickness of less than 200 μm .

2.4 General warning notices



DANGER

Danger due to bursting of the coupling

The coupling may burst if it is not used properly. There is a risk of fatal injury from flying fragments. Bursting of the coupling can lead to an explosion in potentially explosive atmospheres.

- Use the coupling for the purpose for which it is intended.



! DANGER

Risk of explosion when using coupling parts without Ex marking

Coupling parts without Ex marking have not been approved for use in potentially explosive atmospheres. These coupling parts can lead to an explosion during operation.

- Only use couplings with Ex marking in potentially explosive atmospheres.



! DANGER

Danger

Risk of injury due to the use of unsuitable and/or damaged components. The use of unsuitable and/or damaged components can lead to an explosion in potentially explosive atmospheres.

- Observe the information regarding conditions of use.



! DANGER

Danger of explosion

Improper operation of the coupling can lead to an explosion in potentially explosive atmospheres.

- Please observe the notes concerning operation of the coupling in potentially explosive atmospheres.



! DANGER

Danger from hot coupling parts

Risk of injury due to hot surfaces. Hot coupling parts can lead to an explosion in potentially explosive atmospheres.

- Wear suitable protective equipment (gloves, safety goggles).
- Ensure that the area is not at risk of explosion.



! WARNING

Risk of chemical burns due to chemical substances

There is a risk of chemical burns when handling aggressive cleaning agents.

- Please observe the manufacturer's information on how to handle cleaning agents and solvents.
- Wear suitable protective equipment (gloves, safety goggles).

! CAUTION

Physical injury

Risk of injury due to falling coupling parts.

- Secure the coupling parts to prevent them from falling.

Description

The N-EUPEX couplings described here are torsionally flexible, damping pin couplings and are available in various types and sizes. The couplings can be used in accordance with the ATEX Directive in potentially explosive atmospheres if they have a CE marking.

Types D, E and M are fail-safe.

These instructions describe the assembly and operation of an N-EUPEX coupling arranged horizontally with a shaft-hub connection made by a cylindrical or conical bore with parallel key and a flange (coupling part 10). Please consult Flender if you want to use a different type of installation.

Application

N-EUPEX couplings are designed for use in all kinds of machines.

Design

The diagrams show the various types with their constituent parts and their part numbers.

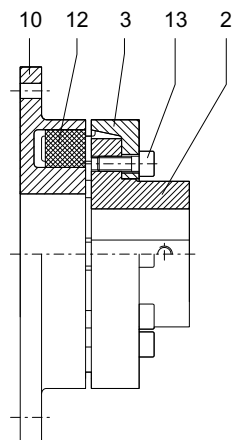

- 2 Coupling part 2
- 3 Coupling part 3
- 10 Coupling part 10
- 12 Flexible element
- 13 Cylinder-head screw

Figure 3-1 Type D

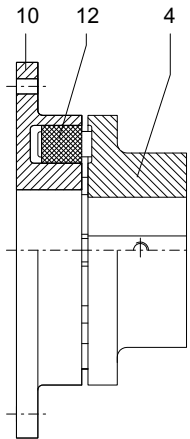

- 4 Coupling part 4
- 10 Coupling part 10
- 12 Flexible element

Figure 3-2 Type E

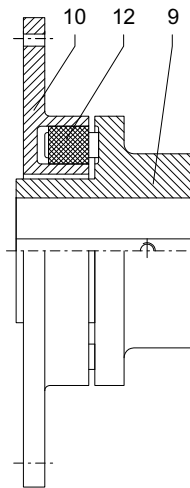

- 9 Coupling part 9
- 10 Coupling part 10
- 12 Flexible element

Figure 3-3 Type M

Application planning

Check the delivery for damage and for completeness. Report any damage and/or missing parts to Flender immediately.

The coupling is delivered in individual parts and preassembled groups. Preassembled groups may not be dismantled.

4.1 Transport of the coupling



<p>! WARNING</p> <p>Severe personal injury due to improper transport</p> <p>Severe personal injury due to falling components or due to crushing. Damage to coupling parts possible due to use of unsuitable transport means.</p> <ul style="list-style-type: none"> • Only use lifting gear and load suspension devices with sufficient load bearing capacity for transport. • Please observe the symbols applied on the packaging.

If not specifically contractually agreed otherwise, the packaging complies with the HPE Packaging Directive.

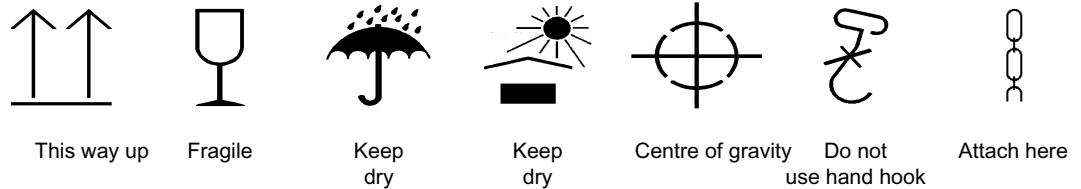

Figure 4-1 Transport symbols

4.2 Storage of the coupling

<p>NOTICE</p> <p>Property damage due to improper storage</p> <p>Negative changes to the physical properties of the coupling and/or coupling damage.</p> <ul style="list-style-type: none"> • Please observe the information about storing the coupling.
--

4.2 Storage of the coupling

The coupling, unless not specifically ordered otherwise, is supplied with preservation and can be stored for up to 3 months.

Note

Information about storing the coupling

- Ensure that the storage room is dry (relative humidity < 65 %) and free of dust.
- Ensure that there is no condensation.
- Do not store the coupling together with corrosive chemicals, acids, caustic solutions, etc.
- If the coupling contains elastomer components, ensure that there are no devices in the storage room that produce ozone, such as fluorescent lights, mercury vapour lamps or high-voltage electrical equipment.
- Store the coupling on suitable supports or in suitable containers.

Long-term storage

NOTICE
Property damage due to improper long-term storage
Negative changes to the physical properties of the coupling and/or coupling damage.
<ul style="list-style-type: none"> • Note the handling instructions for long-term storage.

1. You can find the required type of preservative agent in the following table (types of preservative agents for long-term storage).
2. Remove the elastomer components. These must not come into contact with cleaning agents and long-term preservative agents.
3. Clean the coupling parts.
4. Apply the stipulated preservative agent.
5. Store the coupling parts and the elastomer components separately.

Table 4-1 Types of preservative agents for long-term storage

Preservative agents	Features	Indoor storage	Outdoor storage
Oil spray	Anti-corrosion agent	Up to 12 months	Up to 4 months
Tectyl 846 or similar	Long-term preservative agent on wax basis	Up to 36 months	Up to 12 months
Emulsion cleaner + VCI foil	Active system, reusable	Up to 5 years	Up to 5 years

Assembly

Assembly of the coupling comprises the following steps:

- Preparatory work (Page 21)
- Assembling the coupling (Page 29)
- Aligning the coupling (Page 30)



DANGER

Danger due to bursting of the coupling

If you do not observe the information stipulated here regarding assembly, this can lead to bursting of the coupling during operation. There is a risk of fatal injury from flying fragments. Bursting of the coupling can lead to an explosion in potentially explosive atmospheres.

- Please observe all the stipulations concerning assembly.

Note

Information about the assembly of the coupling

- Only use undamaged components for the assembly of the coupling.
- Follow the assembly sequence.
- Please ensure that there is sufficient space at the assembly location and that the location is tidy and clean in order to be able to assemble and maintain the coupling without any risk.
- If a dimension drawing has been created for the coupling, please observe the information it contains as a matter of priority.

5.1 Preparatory work

Note

Please consult Flender if you want to machine a conical finished bore.

Carry out the following steps if the coupling does not have a finished bore:

- Milling the parallel keyway (Page 22)
- Milling the parallel keyway (Page 24)
- Machining an axial locking mechanism (Page 24)
- Balancing the coupling (Page 28)

Note

The customer is responsible for execution of the finishing work on the coupling. Flender shall have no liability whatsoever for claims under warranty arising from finishing work that has not been carried out adequately.

5.1.1 Milling the parallel keyway

The diameter of the finished bore depends on the shaft used.

Recommended assigned fits

In the following table you can find the recommended assigned fits for bores with a parallel key connection. The assigned fit m6 / H7 is especially suitable for a host of applications.

Table 5-1 Recommended assigned fits for bores with parallel key connection

Description	Push fit		Press fit		Interference fit		
	Not suitable for reversing operation		Suitable for reversing operation				
Shaft tolerance	j6	h6	h6	k6	m6	n6	h6
Bore tolerance	H7	J7	K7	H7	H7	H7	M7

Procedure

1. Remove the flexible elements (12).
2. Remove the preservation and clean the coupling parts 2 (2), 4 (4) or 9 (9) to be machined.
3. Clamp the coupling to the areas marked with  in the diagram below.
4. Machine the finished bore in accordance with the diagram below.

Note

Diameter of the finished bore

The diameter of the finished bore may not exceed the specified maximum diameter.

- Please observe the maximum diameters specified in section Speeds, geometry data and weights (Page 53).

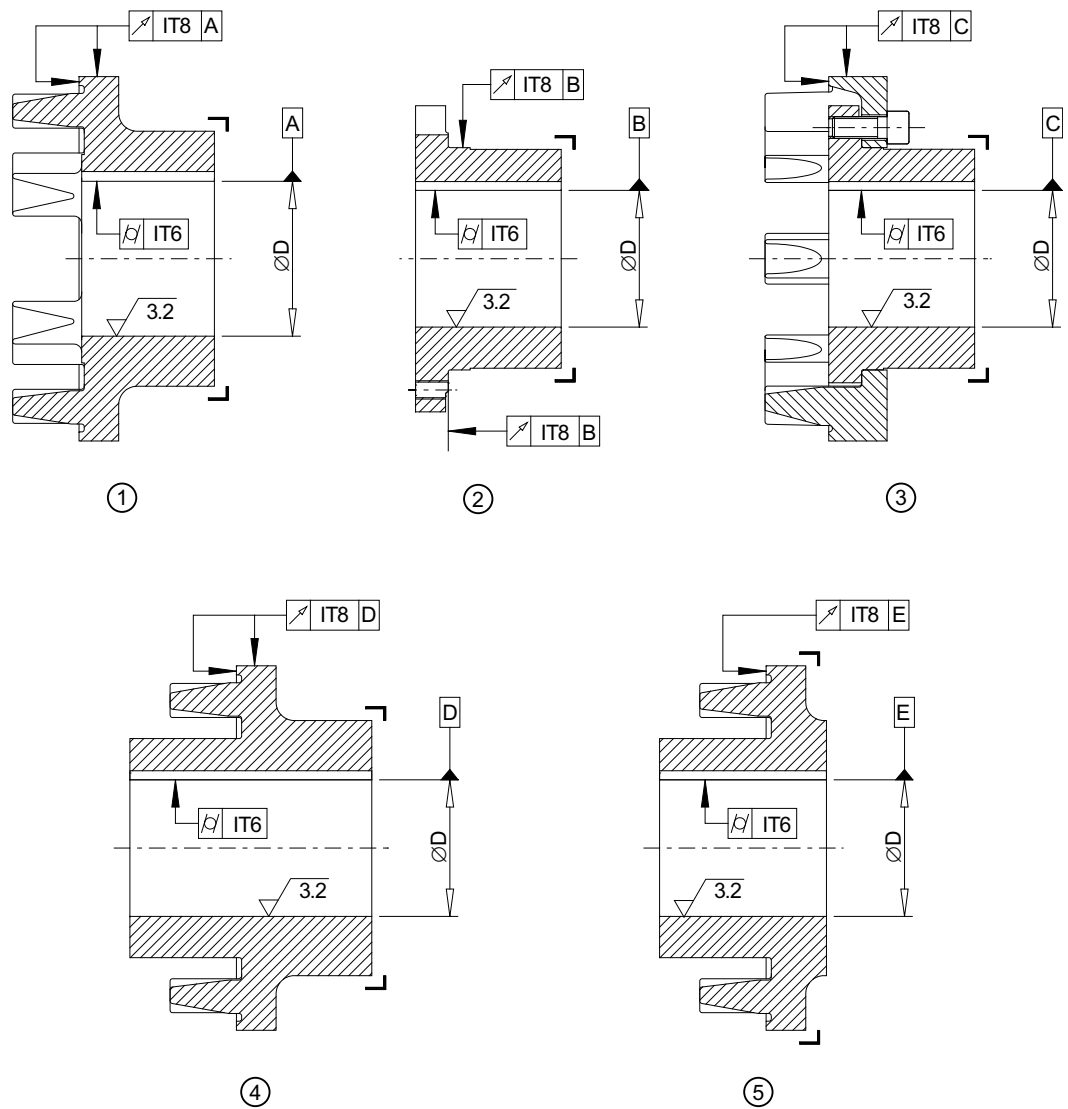

- ① Coupling part 4
- ② Coupling part 2
- ③ Coupling part 2/3
- ④ Coupling part 9
- ⑤ Coupling part 9, short hub

Figure 5-1 Tolerances for finished bore

5.1.2 Milling the parallel keyway

Position of the parallel keyway

The table below states the required position for the parallel keyway in the coupling parts depending on the coupling type.

Table 5-2 Position of the parallel keyway

Coupling part	Position of the parallel keyway
2	Centred between the through-holes
4	Beneath a cam
9	Beneath a cam

Applicable standards

- If the coupling is intended for use under normal operating conditions, mill the parallel keyway according to DIN 6885/1 ISO JS9.
- If the coupling is intended for reversing operation, mill the parallel keyway according to DIN 6885/1 ISO P9.
- If you want to mill a parallel keyway that does not correspond to DIN 6885/1, please consult Flender.

5.1.3 Machining an axial locking mechanism

The coupling part is secured by a set screw or an end plate to prevent axial movements.

Please consult Flender if you want to use an end plate.

Note the following when using a set screw:

- Diameter and axial position of the tapped hole in the hub
- Position of the tapped hole with respect to the parallel keyway
- Selection of the set screw

Diameter and axial position of the tapped hole in the hub

The following diagram shows the axial position of the tapped hole.

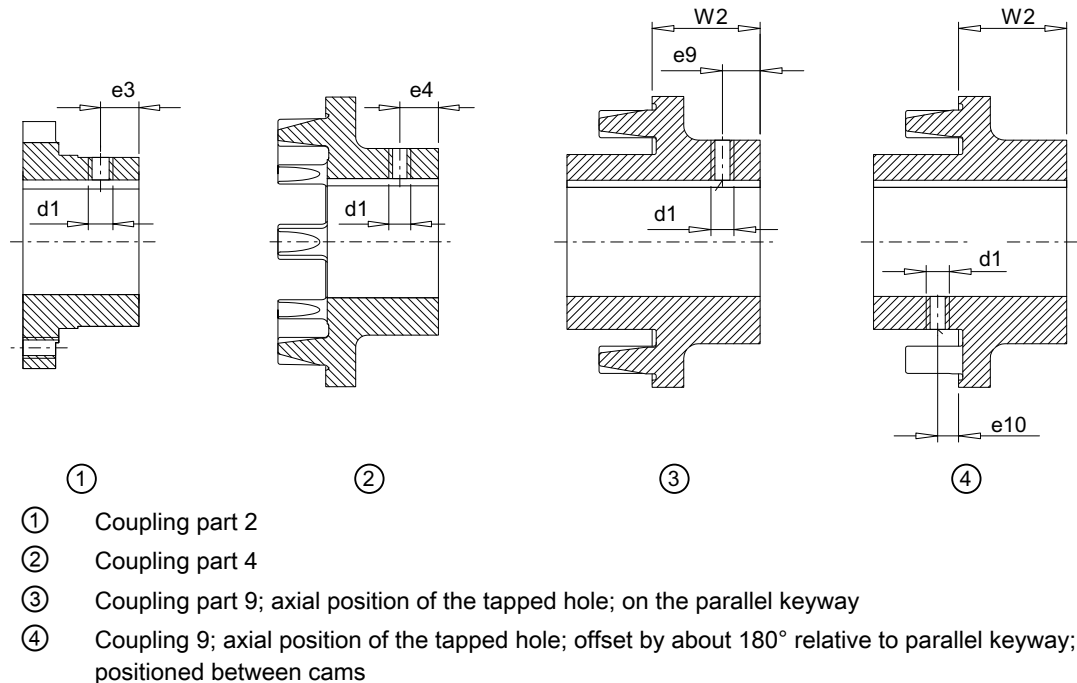

Figure 5-2 Diameter and axial position of the tapped hole in the hub

The following table contains the values for the diameter and axial position of the tapped hole depending on the size of the coupling.

Table 5-3 Diameter and axial position of the tapped hole, tightening torque

Size	d1	e3 mm	e4 mm	e9 mm	e10 mm	Tightening torque
						T _A Nm
68	M6	-	8	-	-	4
80	M6	-	12	-	-	4
95	M6	-	15	-	-	4
110	M6	9	18	-	-	4
125	M8	12	20	12	12	8
140	M8	15	22	10	15	8
160	M10	20	25	-	15	15
180	M12	30	32	20	-	25
200	M12	30	40	17	15	25
225	M12	35	40	25	20	25
250	M16	40	45	25	20	70
280	M16	45	45	25	25	70
315	M16	50	-	-	25	70
350	M20	60	-	-	-	130

Size	d1	e3 mm	e4 mm	e9 mm	e10 mm	Tightening torque
						T _A Nm
400	M20	70	-	-	-	130
440	M24	80	-	-	-	230
480	M24	90	-	-	-	230
520	M24	100	-	-	-	230

Apply the recommended tightening torques in accordance with the stipulations in section Tightening procedure (Page 59).

Position of the tapped hole with respect to the parallel keyway

The tapped hole for the set screw is generally positioned on the parallel keyway. This does not apply to the coupling parts listed in the following table.

Table 5-4 Position of the tapped hole with respect to the parallel keyway for coupling parts 2 and 4

Coupling part	Size	Finished bore mm	Position of the tapped hole
2	110	≥ 30	Offset 180° relative to parallel keyway
4	68	≥ 20	Offset 180° relative to parallel keyway

The table below refers to the diagram "Diameter and axial position of the tapped hole in the hub" in this chapter.

Table 5-5 Position of the tapped hole with respect to the parallel keyway with coupling part 9

Coupling part	Size	Dimension W2 [mm]	Position of the tapped hole
9	125	< 36	④
		36 ... 39	③
9	140	< 36	④
		36	③
9	160		④
9	180		③
9	200	< 56	④
		56	③
9	225	< 55	④
		55 ... 78	③
9	250	< 55	④
		55 ... 69	③
9	280	< 55	④
		55 ... 60	③
9	315		④

Selection of the set screw

 CAUTION
Physical injury Danger of injury from protruding set screw. <ul style="list-style-type: none">• Please observe the information about selecting the set screw.

As set screws use threaded studs in accordance with ISO 4029 with a toothed cup point. The size of the set screw is determined by the bore made. The set screw should fill out the tapped hole as much as possible and must not protrude beyond the hub.

5.1.4 Balancing the coupling

Notes on balancing the coupling

Please note the following when balancing the coupling:

- Select the balancing quality according to the application (but at least G16 in accordance with DIN ISO 21940).
- Observe the balancing specification according to DIN ISO 21940-32.
- Machine the balancing bore on a large radius with adequate clearance to the flexible element webs / pockets and to the cams and the outer circumference.

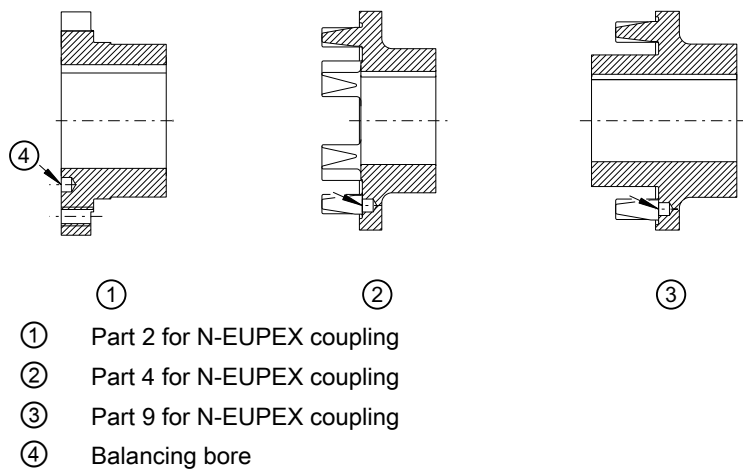

Figure 5-3 Position of the balancing bore for single-plane balancing

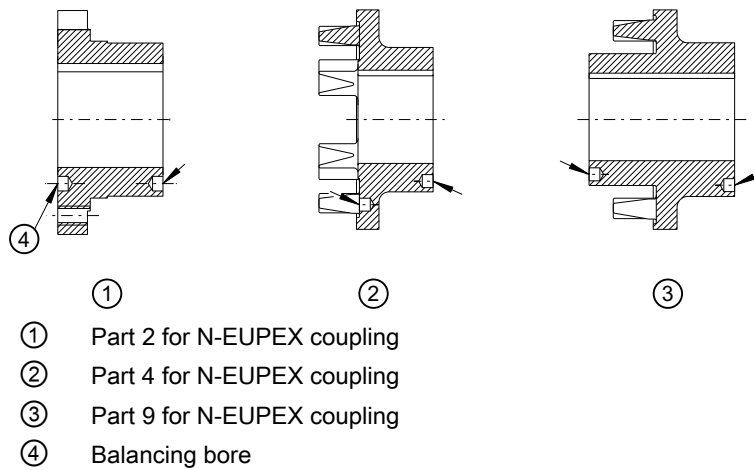

Figure 5-4 Position of the balancing bore for two-plane balancing

Note

A better balancing result can be achieved by balancing the coupling parts (2 and 3) when they are bolted together as an assembly. When balancing all parts together, mark the position of the components relative to one another.

5.2 Assembling the coupling

NOTICE
<p>Property damage</p> <p>Damage to the elastomer components from cleaning agents.</p> <ul style="list-style-type: none"> • Ensure that the elastomer components do not come into contact with cleaning agents.

NOTICE
<p>Property damage</p> <p>Damage to the shaft end, the coupling parts and/or the parallel key.</p> <ul style="list-style-type: none"> • Note the following handling instruction.

Procedure

1. Unscrew the set screw out of coupling parts 2 (2) and 4 (4) or 9 (9) until it is no longer possible for there to be a collision with the parallel key or the shaft.
2. Clean the bores and shaft ends.
3. Coat the bores of coupling parts 2 (2), 4 (4) or (9) and the shafts with MoS₂ assembly paste (e.g. Microgleit LP 405).
4. If you have dismantled the coupling part 3 (3), mount the coupling part 3 (3) on the shaft before fitting the coupling part 2 (2).
5. Mount the coupling part 2 (2), 4 (4) or 9 (9) on the shaft.

Note

Coupling parts with conical bore

Mount the coupling part 2 (2), 4 (4) or 9 (9) with conical bore and parallel keyway on the shaft in cold condition. Secure the coupling part with a suitable end plate without pulling the coupling part further onto the cone (fitting dimension = 0).

Note

Coupling parts with cylindrical bore

To make assembly easier, you can heat coupling part 2 (2), 4 (4) or 9 (9) with cylindrical bore up to a maximum of 150 °C if required. Note when doing this the temperature range of the flexible elements (12) (refer to section N-EUPEX flexible elements (12) (Page 60)). Remove the flexible elements (12) if necessary. Protect adjacent components against damage and heating to temperatures above 80 °C.

6. Secure the coupling part 2 (2), 4 (4) or 9 (9) with a set screw or an end plate. When securing with a set screw the shaft must not protrude or be set back from the inner side of the hub.
7. Tighten up the set screw or the screw to attach the end plate to the specified tightening torque T_A (for the set screw please see section Machining an axial locking mechanism (Page 24)).

8. Flange-mount the coupling part 10 (10) on the mating part.

Note

Notes about flange-mounting the coupling part 10 (10)

- Use bolts of strength class 8.8 or higher.
 - Dimension the depth of engagement of the bolts adequately (the following applies to steel materials: depth of engagement $\geq 1.5 \cdot$ thread diameter).
 - Select the tightening torque according to the directive VDI 2230.
 - If you use a specific flange version, the customer is responsible for ensuring that the flange connection is made properly. Flender shall have no liability whatsoever for claims under warranty arising from an inadequately dimensioned flange connection.
-

9. If you have removed the flexible elements (12), reinstall them.
10. Tighten the bolts in the coupling part 2 (2) and 3 (3) to the specified torque T_A (see section Tightening torques and widths A/F (Page 58)).

5.3 Aligning the coupling

5.3.1 Purpose of alignment

The shafts that are joined by the coupling are never on an ideal precise axis but have a certain amount of misalignment.

Misalignment in the coupling leads to restoring forces that can stress adjacent machine parts (e.g. the bearings) to an unacceptable extent.

The misalignment values in operation result from the following:

- Misalignment due to assembly
Incorrect position due to a lack of precision when aligning
- Misalignment due to operation
Example: Load-related deformation, thermal expansion

You can minimise misalignment by aligning after assembly. A lower misalignment in the coupling has the following advantages:

- Reduced wear of the elastomer components
- Reduced restoring forces
- Misalignment reserves for operation of the coupling

You can find the maximum permitted shaft misalignment values during operation in section Shaft misalignment values during operation (Page 57).

5.3.2 Possible misalignment

The following types of misalignment can occur:

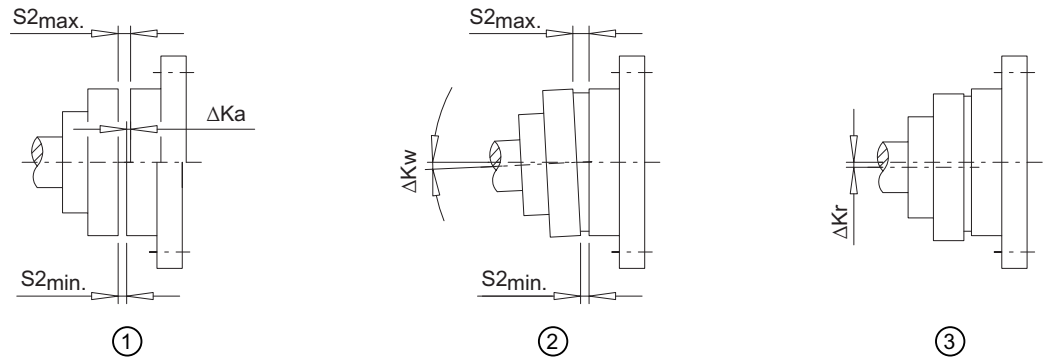

- ① Axial misalignment (ΔK_a)
- ② Angular misalignment (ΔK_w)
- ③ Radial misalignment (ΔK_r)

Figure 5-5 Possible misalignment

5.3.2.1 Axial misalignment

Set the axial misalignment ΔK_a to a value within the permissible tolerance range of dimension S_2 .

You can find the values for dimension S_2 in section Speeds, geometry data and weights (Page 53).

5.3.2.2 Angular misalignment

Determine the value ΔS_2 ($\Delta S_2 = S_{2_{max}} - S_{2_{min}}$). The determined value ΔS_2 may not exceed the value $\Delta S_{2_{perm}}$.

You can find the values for $\Delta S_{2_{perm}}$ in section Shaft misalignment values during operation (Page 57).

If required, you can calculate the angular misalignment ΔK_w as follows:

$$\Delta K_w [\text{rad}] = \Delta S_2 / DA$$

$$\Delta K_w [\text{deg}] = (\Delta S_2 / DA) \cdot (180 / \pi)$$

If required, you can calculate the permissible angular misalignment $\Delta K_{w_{perm}}$ as follows:

$$\Delta K_{w_{perm}} [\text{rad}] = \Delta S_{2_{perm}} / DA$$

$$\Delta K_{w_{perm}} [\text{deg}] = (\Delta S_{2_{perm}} / DA) \cdot (180 / \pi)$$

DA in mm see section Speeds, geometry data and weights (Page 53)

$\Delta S_{2_{perm}}$ see section Shaft misalignment values during operation (Page 57)

5.3.2.3 Radial misalignment

Determine the value ΔK_r . The determined value ΔK_r may not exceed the value $\Delta K_{r_{perm}}$.

You can find the permissible radial misalignment $\Delta K_{r_{perm}}$ in section Shaft misalignment values during operation (Page 57).



! DANGER

Danger due to igniting deposits

During use in potentially explosive atmospheres deposits from heavy metal oxides (rust) can ignite due to friction, impact or friction sparks and lead to an explosion.

- Ensure through the use of an enclosure or other suitable measures that the deposition of heavy metal oxides (rust) on the coupling is not possible.

In order to ensure safe commissioning, carry out various tests prior to commissioning.

Testing before commissioning



! DANGER

Danger

Overload conditions can occur during the commissioning of the coupling. The coupling can burst and metal parts can be flung out. There is a risk of fatal injury from flying fragments. Bursting of the coupling can lead to an explosion in potentially explosive atmospheres.

- Carry out the tests prior to commissioning.
- Do not touch the rotating coupling.

1. Check the tightening torques of the screws of the coupling in accordance with section Tightening torques and widths A/F (Page 58).
2. Check the tightening torques of the foundation bolts of the coupled machines.
3. Check whether suitable enclosures (ignition protection, coupling guard, touch protection) have been installed and that the function of the coupling has not been adversely affected by the enclosure. This also applies to test runs and rotational direction checks.

Operation

7.1 Normal operation of the coupling

The coupling runs quietly and shock-free during normal operation.

7.2 Faults - causes and rectification

A form of behaviour which is different to normal operation is classed as a fault and has to be rectified immediately.

Look out specifically for the following faults during coupling operation:

- Unusual coupling noise
- Sudden occurrence of shocks

7.2.1 Procedure in the event of malfunctions



DANGER

Danger due to bursting of the coupling

There is a risk of fatal injury from flying fragments. Bursting of the coupling can lead to an explosion in potentially explosive atmospheres.

- Switch off the unit at once if any malfunctions occur.
- Note during the maintenance work the possible causes of faults and the notes on rectifying them.

Proceed as described below if there is a malfunction of the coupling during operation:

1. De-energise the drive immediately.
2. Initiate the required action for repair, taking into consideration the applicable safety regulations.

If you cannot determine the cause or if you cannot carry out repair work with your own means, request one of our customer service technicians.

7.2.2 Identifying the fault cause

Faults occur frequently due to application errors or they occur due to operational circumstances such as wear of wearing parts or changes to the system.

The faults and fault causes listed below only serve as an indication for troubleshooting. In the case of a complex system be sure to include all the system components in the search for the fault.



	<p>WARNING</p> <p>Physical injury</p> <p>Injury from rotating parts.</p> <ul style="list-style-type: none"> • Only carry out work on the coupling when it is not moving. • Secure the drive unit against being operated accidentally. • Attach a notice to the switch stating clearly that work is being carried out on the coupling. • Before starting any work, make sure that the unit is free from loads.
--	---

Intended use

The coupling is only approved for the applications specified in these instructions. Please observe all the stipulations in section Intended use (Page 13).

7.2.2.1 Possible faults

Table 7-1 Table of faults

Fault	Cause	Rectification
Sudden changes in the noise level and/or sudden occurrences of shocks	Wear of wearing parts	Follow the instructions given in section Replacing wearing parts (Page 38).
	Changed alignment	Follow the instructions given in section Correcting the changed alignment (Page 39).
	Coupling not suitable for the operating conditions. Check the possible causes given in section Unsuitable coupling (Page 37).	Use a coupling that is suitable for the operating conditions.
	Incorrect assembly of the coupling. Check the possible causes given in sections Assembly-related causes (Page 37) and Specific installation-related and maintenance-related causes (Page 38).	Reassemble the coupling in accordance with these instructions. Please observe all the stipulations and requirements given in chapter Assembly (Page 21).
	Incorrect maintenance of the coupling. Check the possible causes given in sections Maintenance-related causes (Page 38) and Specific installation-related and maintenance-related causes (Page 38).	Please observe all the stipulations and requirements given in chapter Servicing (Page 41).

Fault	Cause	Rectification
Presence of vibration	Coupling not suitable for the operating conditions. Check the possible causes given in section Unsuitable coupling (Page 37).	Use a coupling that is suitable for the operating conditions.
	Incorrect assembly of the coupling. Check the possible causes given in sections Assembly-related causes (Page 37) and Specific installation-related and maintenance-related causes (Page 38).	Reassemble the coupling in accordance with these instructions. Please observe all the stipulations and requirements given in chapter Assembly (Page 21).
	Incorrect maintenance of the coupling. Check the possible causes given in sections Maintenance-related causes (Page 38) and Specific installation-related and maintenance-related causes (Page 38).	Please observe all the stipulations and requirements given in chapter Servicing (Page 41).

7.2.2.2 Possible causes

Unsuitable coupling

- Important information on the description of the drive unit and the environment were not available when the coupling was chosen.
- System torque too high and/or torque dynamics not permissible.
- System speed too high.
- Application factor not selected correctly.
- Chemically aggressive environment not taken into consideration.
- Coupling not suitable for the ambient temperature.
- Diameter and/or assigned fit of the finished bore not permissible.
- Width across corners of the parallel keyways greater than the width across corners of the parallel keyways in accordance with DIN 6885/1 for the maximum permissible bore.
- Shaft-hub connection incorrectly sized.
- Maximum permissible load conditions not taken into consideration.
- Maximum permissible overload conditions not taken into consideration.
- Dynamic load conditions not taken into consideration.
- Coupling and the machine and/or drive train form a critical torsional, axial or bending vibration system.

Assembly-related causes

- Damaged parts installed.
- Shaft diameter outside the stipulated tolerance range.

- Coupling parts interchanged and hence not assigned to the specified shaft.
- Stipulated locking elements to prevent axial movements not installed.
- Stipulated tightening torques not adhered to.
- Bolts inserted dry or greased.
- Flange surfaces of screwed connections not cleaned.
- Alignment and/or shaft misalignment values not set in accordance with the instructions.
- Coupled machines were not correctly connected to the foundation so that a shifting of the machines leads to an impermissible displacement of the coupling parts.
- Coupled machines not earthed adequately.
- Coupling guard used is not suitable.

Maintenance-related causes

- Stipulated maintenance intervals not adhered to.
- Spare parts that were used were not original spare parts from Flender.
- Flender spare parts that were used were old or damaged.
- Leak in the area of the coupling not detected so that chemically aggressive substances damage the coupling.
- Indications of faults, such as noise or vibration, were not heeded.
- Stipulated tightening torques not adhered to.
- Alignment and/or shaft misalignment values not set in accordance with the instructions.

Specific installation-related and maintenance-related causes

- Flexible elements (12) not fitted.
- Fitted flexible elements (12) heated up excessively when applying heat to the coupling parts.
- Flexible elements (12) of different types or age are used.
- Flexible elements (12) not replaced as sets.

7.2.3 Correcting faults

7.2.3.1 Replacing wearing parts

Flexible elements (12) are subject to wear and this wear can result in torsional backlash.

Procedure

1. Check the wear on the flexible elements (12) (see section Maximum permissible torsional backlash (Page 42)).
2. Replace the flexible elements (12) if necessary (see section Replacing wearing parts (Page 43)).

7.2.3.2 Correcting the changed alignment

A changed alignment of the coupling during operation often occurs when the coupled machines shift towards one another. A cause of this can be loose foundation bolts.

Procedure

1. Correct the cause for the change in alignment.
2. Check the wearing parts for wear and replace them as required.
3. Check the locking elements that prevent axial movements and correct these as required.
4. Realign the coupling.

8.1 Maintenance intervals



 DANGER
<p>Danger due to bursting of the coupling</p> <p>The coupling can burst if the maintenance intervals are not adhered to. There is a risk of fatal injury from flying fragments. Bursting of the coupling can lead to an explosion in potentially explosive atmospheres.</p> <ul style="list-style-type: none"> • Please observe all the stipulations concerning maintenance of the coupling in this section.



 DANGER
<p>Danger due to bursting of the coupling</p> <p>The coupling can burst if the maximum permitted torsional backlash is exceeded. There is a risk of fatal injury from flying fragments. Bursting of the coupling can lead to an explosion in potentially explosive atmospheres.</p> <ul style="list-style-type: none"> • Note also the actual wear of the elastomer components.



 WARNING
<p>Physical injury</p> <p>Injury from rotating parts.</p> <ul style="list-style-type: none"> • Only carry out work on the coupling when it is not moving. • Secure the drive unit against being operated accidentally. • Attach a notice to the switch stating clearly that work is being carried out on the coupling. • Before starting any work, make sure that the unit is free from loads.

Check the torsional backlash between the coupling parts at the specified maintenance intervals. The maximum permissible torsional backlash for the various coupling sizes can be found in section Maximum permissible torsional backlash (Page 42).

Table 8-1 Maintenance intervals

Type	Initial maintenance	Follow-up maintenance
D	3 months after commissioning	Every 12 months
E		
M		

Note

Shorter maintenance intervals

If necessary, set shorter maintenance intervals depending on actual wear.

8.2 Maximum permissible torsional backlash

In order to calculate the torsional backlash, rotate one coupling part without applying torque up to the stop. Mark both of the coupling halves in the way shown in the diagram below. Turn the coupling part in the opposite direction up to the stop. The markings on both halves will then move apart. The distance between the markings corresponds to the torsional backlash.

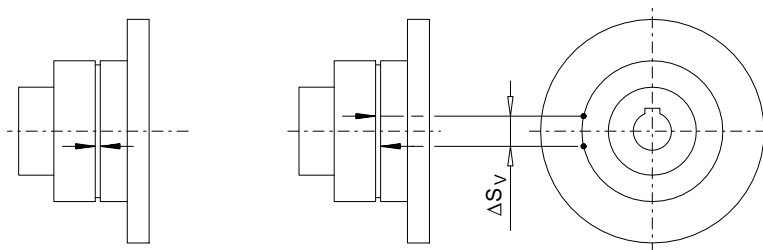

Figure 8-1 Markings for calculating the torsional backlash

Table 8-2 Maximum permissible torsional backlash for the types D E and M (sizes 68 to 200)

Size	68	80	95	110	125	140	160	180	200
Maximum permissible torsional backlash ΔS_v [mm]	5.5	5.0	6.0	7.0	8.0	8.0	8.0	8.0	8.5

Table 8-3 Maximum permissible torsional backlash for the types D, E and M (sizes 225 to 520)

Size	225	250	280	315	350	400	440	480	520
Maximum permissible torsional backlash ΔS_v [mm]	9.0	10.0	11.5	10.5	11.5	13.0	14.0	15.5	17.5

8.3 Replacing wearing parts



! DANGER

Danger due to bursting of the coupling

If you do not observe the information stipulated here regarding replacement of wearing parts, this can lead to bursting of the coupling during operation. There is a risk of fatal injury from flying fragments. Bursting of the coupling can lead to an explosion in potentially explosive atmospheres.

- Please observe all the stipulations concerning the replacement of wearing parts.

Replace the flexible elements (12) if the maximum permissible torsional backlash has been reached. The method used to replace the flexible elements (12) varies according to the coupling type.

Type D

Replace the flexible elements (12) without moving the coupled machines.

1. Undo the connection between coupling parts 2 (2) and 3 (3).
2. Move the coupling part (3) axially.
The flexible elements (12) are freely accessible after coupling part 2 (2) has been turned.

Note

Loosening coupling part 3 (3)

To make it easier to loosen coupling part 3 (3), a tapped jacking hole is machined in coupling part 3 (3) on coupling sizes 440 to 520.

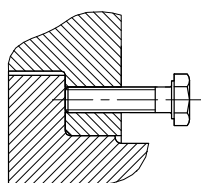

Figure 8-2 Tapped jacking hole for loosening coupling part 3 (3)

3. Remove the flexible elements (12).
4. Install the new flexible elements (12).
Please observe the information in section Use and storage of flexible elements (12) (Page 59).

When reinstalling the coupling parts please observe the information in chapters Assembly (Page 21) and Commissioning (Page 33).

Types E and M

1. In order to replace the flexible elements (12), move the coupled machines apart.
2. Remove the flexible elements (12).
3. Install the new flexible elements (12).
Please observe the information in section Use and storage of flexible elements (12) (Page 59).

When reinstalling the coupling parts please observe the information in chapters Assembly (Page 21) and Commissioning (Page 33).

8.4 Removing the coupling



 DANGER
Danger from burners and hot coupling parts
Risk of injury due to burners and hot surfaces. Burners or hot coupling parts can lead to an explosion in potentially explosive atmospheres.
<ul style="list-style-type: none">• Wear suitable protective equipment (gloves, safety goggles).• Ensure that the area is not at risk of explosion.

Procedure

1. Move the coupled machines apart.
2. Secure the coupling parts to prevent them from falling.
3. Remove the axial locking elements (set screw, end plate).
4. Use a suitable pulling fixture.
5. Heat up the coupling part 2 (2), 4 (4) or 9 (9) using a burner above the parallel keyway along its length to maximum 80 °C.
6. Pull off the coupling part 2 (2), 4 (4) or 9 (9). Use suitable lifting gear when doing this.
7. Check the hub bore and the shaft for damage and protect them against corrosion.
8. Remove the screws from the coupling part 10 (10).
9. Press the coupling part 10 (10) out of the centring device using the tapped jacking hole.
10. Replace any damaged parts.

When reinstalling the coupling parts please observe the information in chapters Assembly (Page 21) and Commissioning (Page 33).

Service and support

Contact

When ordering spare parts, requesting a customer service technician or in the case of technical queries, please contact our factory or one of our customer service addresses:

Flender GmbH

Schlavenhorst 100

46395 Bocholt

Germany

Tel.: +49 (0)2871/92-0

Fax.: +49 (0)2871/92-2596

Flender GmbH (<http://www.flender.com>)

Disposal

Disposal of the coupling

Dispose of the coupling parts according to applicable national regulations or recycle them.

Spare parts

11.1 Ordering spare parts

By stocking the most important spare parts at the installation site you can ensure that the coupling is ready for use at any time.

Note

Original spare parts

Only use original spare parts from Flender. Flender only accepts liability for original spare parts from Flender.

Other spare parts are not tested and approved by Flender. Non-approved spare parts may possibly change the design characteristics of the coupling and thus impact active and/or passive safety.

Flender will accept no liability or warranty whatsoever for damage occurring as a result of the use of non-approved spare parts. The same applies to any accessories that were not supplied by Flender.

You can find the available spare parts for the coupling described here at Spare parts drawing and spare parts list (Page 50).

You will find our contact data for ordering spare parts in Service and support (Page 45).

Information required when ordering spare parts

- Flender order number with item
- Flender drawing number
- Coupling type and size
- Part number (refer to Spare parts drawing and spare parts list (Page 50))
- Dimensions of the spare part, for example:
 - Bore
 - Bore tolerance
 - Parallel keyway and balancing
- Special dimensions, for example, flange connection dimensions, intermediate sleeve length or brake drum dimensions

11.2 Spare parts drawing and spare parts list

- Any special properties of the spare part, such as, for example:
 - Temperature resistance
 - Electrical insulation
 - Operating fluid
 - Use in potentially explosive atmospheres
- Quantity

11.2 Spare parts drawing and spare parts list

11.2.1 Type D

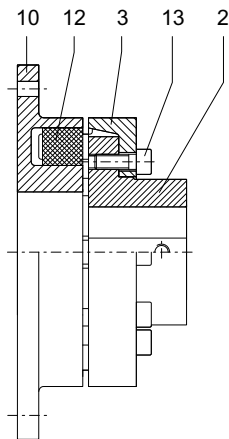

Figure 11-1 Spare parts drawing for type D

Table 11-1 Spare parts list for type D

Part number	Designation
2	Coupling part 2
3	Coupling part 3
10	Coupling part 10
12	Flexible element
13	Cylinder-head screw

11.2.2 Type E

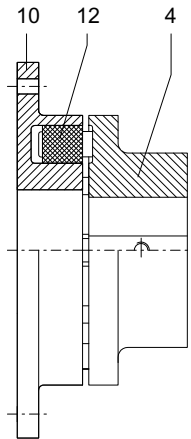

Figure 11-2 Spare parts drawing for type E

Table 11-2 Spare parts list for type E

Part number	Designation
4	Coupling part 4
10	Coupling part 10
12	Flexible element

11.2.3 Type M

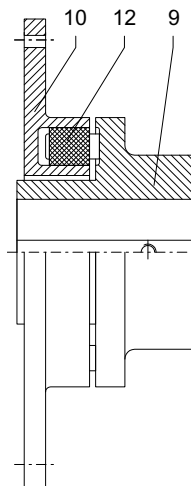

Figure 11-3 Spare parts drawing for type M

Spare parts

11.2 Spare parts drawing and spare parts list

Table 11-3 Spare parts list for type M

Part number	Designation
9	Coupling part 9
10	Coupling part 10
12	Flexible element

Technical data

A.1 Speeds, geometry data and weights

In this section you can find dimension drawings and technical data for N-EUPEX couplings of the following types:

- Type D (Page 53)
- Type E (Page 55)
- Type M (Page 56)

A.1.1 Type D

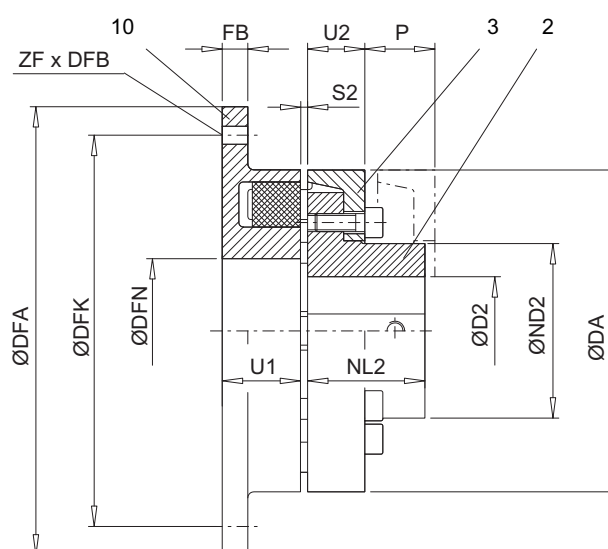

2 Coupling part 2
 3 Coupling part 3
 10 Coupling part 10
 Figure A-1 Type D

Technical data

A.1 Speeds, geometry data and weights

Table A-1 Speeds, geometry data and weights of type D

Size	Speed n _{max.} rpm	Maximum bore ¹⁾														Weight t ²⁾ m kg	
		D2	DA	ND2	NL2	U2	S2	DFA h8	DFN H7	DFK	FB	ZF	DFB optional	U1	P		
		mm	mm	mm	mm	mm	mm	mm	mm	mm	mm	mm	mm	mm	mm	mm	
110	5 300	38	110	62	40	20	2 ... 4	144	62	128	10	6	9	M8	27	33	2.7
125	5 100	45	125	75	50	23	2 ... 4	158	75	142	10	6	9	M8	31	38	3.9
140	4 900	50	140	82	55	28	2 ... 4	180	82	160	13	6	11	M10	34	43	5.6
160	4 250	58	160	95	60	28	2 ... 6	200	95	180	13	7	11	M10	39	47	7.5
180	3 800	65	180	108	70	30	2 ... 6	220	110	200	13	8	11	M10	42	50	10.3
200	3 400	75	200	122	80	32	2 ... 6	248	120	224	16	8	14	M12	47	53	14.7
225	3 000	85	225	138	90	38	2 ... 6	274	135	250	16	8	14	M12	52	61	19.5
250	2 750	95	250	155	100	42	3 ... 8	314	150	282	20	8	18	M16	60	69	28
280	2 450	105	280	172	110	42	3 ... 8	344	170	312	20	8	18	M16	65	73	35
315	2150	100	315	165	125	47	3 ... 8	380	200	348	22	9	18	M16	70	78	47
		120		200													50
350	2 000	110	350	180	140	51	3 ... 8	430	225	390	25	9	22	M20	74	83	64
		140		230													67
400	1 700	120	400	200	160	56	3 ... 8	480	265	440	25	10	22	M20	78	88	86
		150		250													90
440	1 550	130	440	215	180	64	5 ... 10	520	295	480	25	10	22	M20	86	99	114
		160		265													119
480	1 400	145	480	240	190	65	5 ... 10	575	325	528	30	10	26	M24	90	104	146
		180		300													155
520	1 300	150	520	250	210	68	5 ... 10	615	355	568	30	10	26	M24	102	115	177
		190		315													190

¹⁾ Maximum bore for parallel keyway in accordance with DIN 6885/1.

²⁾ Weight applies to one coupling with maximum bore.

A.1.2 Type E

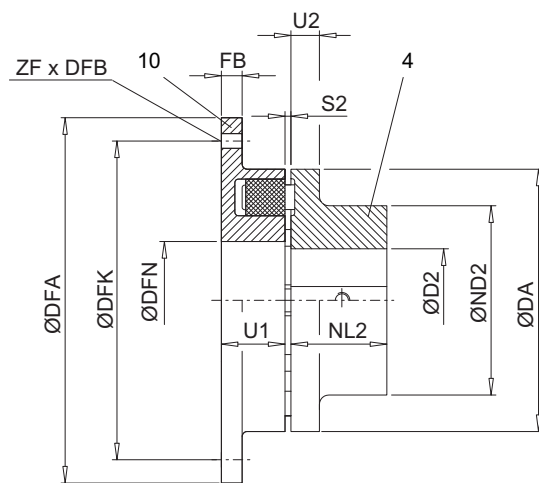

4 Coupling part 4
 10 Coupling part 10
 Figure A-2 Type E

Table A-2 Speeds, geometry data and weights of type E

Size	Speed n_{max} rpm	Maximum bore ¹⁾													Weight ²⁾	
		D2	DA	ND2	NL2	U2	S2	DFA h8	DFN H7	DFK	FB	ZF	DFB optional	U1	m	kg
68	7 000	28	68	50	20	8	2 ... 4	90	34	80	7	6	5.5	M5	20	0.63
80	6 000	38	80	68	30	10	2 ... 4	106	42	94	8	6	6.6	M6	21	1.35
95	5 500	42	95	76	35	12	2 ... 4	120	52	108	8	6	6.6	M6	24	2
110	5 300	48	110	86	40	14	2 ... 4	144	62	128	10	6	9	M8	27	3
125	5 100	55	125	100	50	18	2 ... 4	158	75	142	10	6	9	M8	31	4.5
140	4 900	60	140	100	55	20	2 ... 4	180	82	160	13	6	11	M10	34	5.6
160	4 250	65	160	108	60	20	2 ... 6	200	95	180	13	7	11	M10	39	7.2
180	3 800	75	180	125	70	20	2 ... 6	220	110	200	13	8	11	M10	42	10.3
200	3 400	85	200	140	80	24	2 ... 6	248	120	224	16	8	14	M12	47	14
225	3 000	90	225	150	90	18	2 ... 6	274	135	250	16	8	14	M12	52	17
250	2 750	100	250	165	100	18	3 ... 8	314	150	282	20	8	18	M16	60	26
280	2 450	110	280	180	110	20	3 ... 8	344	170	312	20	8	18	M16	65	32

1) Maximum bore for parallel keyway in accordance with DIN 6885/1.

2) Weight applies to one coupling with maximum bore.

A.1.3 Type M

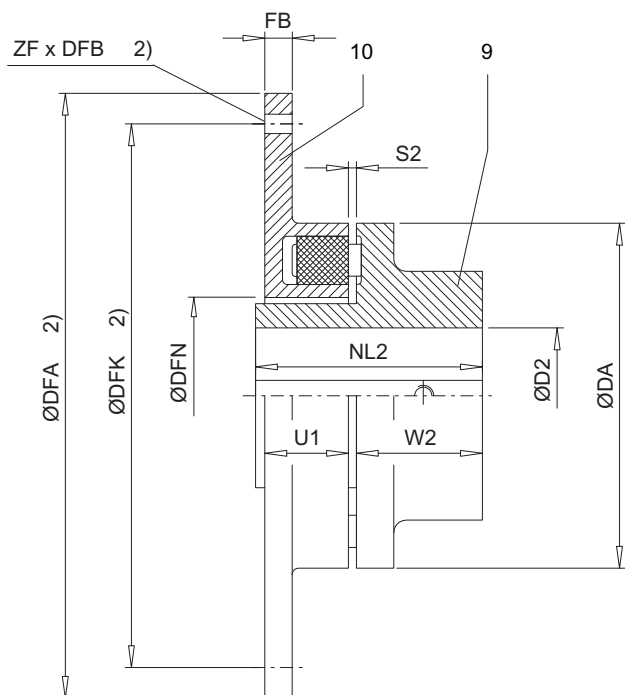

9 Coupling part 9
 10 Coupling part 10
 Figure A-3 Type M

Table A-3 Speeds, geometry data and weights of type M

Size	Speed n_{max} rpm	Maximum bore ¹⁾											Weight ³⁾ m kg
		D2 mm	DA mm	ND2 mm	NL2 mm	W2 mm	S2 mm	DFA ²⁾ h8		DFN mm	FB mm	U1 mm	
								from mm	to mm				
125	5 100	48	125	-	82	39	2 ... 4	158	314.3	75	10	31	8.7
140	4 900	52	140	-	82	36	2 ... 4	180	314.3	82	13	34	10.5
160	4 250	60	160	-	85	30	2 ... 6	200	352.4	95	13	39	14.5
180	3 800	70	180	-	95	61	2 ... 6	220	466.7	110	13	42	23
200	3 400	75	200	-	110	56	2 ... 6	248	466.7	120	16	47	29.5
225	3 000	85	225	-	164	78	2 ... 6	274	466.7	135	16	52	35
250	2 750	90	250	-	159	69	3 ... 8	314	571.5	150	20	60	43
280	2 450	100	280	-	168	60	3 ... 8	344	571.5	170	20	65	57

A.2 Shaft misalignment values during operation

Size	Speed n_{max} rpm	Maximum bore ¹⁾											Weight ³⁾ m kg
		D2	DA	ND2	NL2	W2	S2	DFA ²⁾		DFN	FB	U1	
								h8 from	to				
315	2 150	120	315	-	175	46.5	3 ... 8	380	571.5	200	22	70	71
350 ⁴⁾	2 000	110 ⁴⁾ 140 ⁴⁾	350	180 ⁴⁾ 230 ⁴⁾	140 ⁴⁾	-	3 ... 8	430	571.5	225	25	74	43

- 1) Maximum bore for parallel keyway in accordance with DIN 6885/1.
- 2) Flange outer diameter DFA, hole circle diameter DFK, number ZFB and size of bores DFB in accordance with order.
- 3) Weight applies to one coupling with maximum bore and maximum flange outer diameter DFA.
- 4) Size 350 is only possible in combination with the coupling part 2/3 of type D (instead of part 9). Maximum bore D2, hub diameter ND2 and hub length NL2 are dimensions of the coupling part 2.

A.2 Shaft misalignment values during operation

The following table shows the maximum permissible shaft misalignment values ΔS_{2perm} and ΔKr_{perm} . The values are rounded and specified in mm.

Table A-4 Maximum permissible shaft misalignment values during operation

Size	Coupling speed [rpm]								
	250	500	750	1 000	1 500	2 000	3 000	4 000	5 000
68	0.4	0.3	0.25	0.2	0.2	0.15	0.15	0.1	0.1
80	0.4	0.3	0.25	0.2	0.2	0.15	0.15	0.1	0.1
95	0.5	0.35	0.25	0.25	0.2	0.2	0.15	0.1	0.1
110	0.5	0.35	0.3	0.25	0.2	0.2	0.15	0.1	0.1
125	0.5	0.4	0.3	0.25	0.25	0.2	0.15	0.15	0.1
140	0.6	0.4	0.35	0.3	0.25	0.2	0.2	0.15	
160	0.6	0.5	0.4	0.35	0.3	0.25	0.2	0.15	
180	0.6	0.5	0.4	0.35	0.3	0.25	0.2		
200	0.8	0.55	0.45	0.4	0.3	0.3	0.2		
225	0.8	0.55	0.5	0.4	0.35	0.3	0.25		
250	0.8	0.6	0.5	0.4	0.35	0.3			
280	1	0.7	0.6	0.5	0.4	0.35			
315	1	0.7	0.6	0.5	0.4	0.35			
350	1	0.8	0.6	0.6	0.5				
400	1.2	0.9	0.7	0.6	0.5				
440	1.3	1	0.7	0.7	0.6				
480	1.4	1	0.8	0.7					
520	1.5	1.1	0.9	0.8					

A.3 Tightening torques and widths A/F

You can calculate the numerical values in the table and their intermediate values as follows:

$$\Delta K_{r_{perm}} = \Delta S_{2_{perm}} = (0.1 + DA / 1000) \cdot 40 / \sqrt{n}$$

Coupling speed n in rpm
 DA in mm (see Speeds, geometry data and weights (Page 53))

Radial misalignment $\Delta K_{r_{perm}}$ in mm

The values in column "250 rpm" of the table above apply for speeds of < 250 rpm.

A.3 Tightening torques and widths A/F

Table A-5 Tightening torques for part 13 of type D

N-EUPEX- Coupling	Tightening torque T _A and width A/F SW for Hexagon socket-head screws according to DINEN ISO 4762	
	Size	SW
	T _A Nm	mm
110	14	6
125	17.5	6
140	29	8
160	35	8
180	44	8
200	67.5	10
225	86	10
250	145	14
280	185	14
315	200	14
350	260	17
400	340	17
440	410	17
480	550	19
520	670	19

Apply the recommended tightening torques in accordance with the stipulations in section Tightening procedure (Page 59).

A.4 Tightening procedure

Tighten fastening screws to the specified tightening torque in accordance with the following table:

Table A-6 Tightening procedure

Scatter of the torque applied at the tool	Tightening procedure (As a rule, the tightening procedures listed are within the specified tool torque scatter)
±5 %	<ul style="list-style-type: none"> • Hydraulic tightening with mechanical screwdriver • Torque-controlled tightening with a torque wrench or a torque wrench that gives a signal • Tightening with a precision mechanical screwdriver with dynamic torque measurement

The tightening torques apply to screws/bolts with untreated surfaces that are not oiled or are only lightly oiled, and for screws/bolts that are used with a liquid screw locking agent in accordance with these instructions. Use with lubricant paint or lubricant is not permitted.

A.5 Flexible elements (12)

A.5.1 Use and storage of flexible elements (12)

Note the following concerning the use and storage of the flexible elements (12):

- Storage possible for up to 5 years
- Protect against direct sunlight, artificial light with a high UV-content and extreme temperatures
- Avoid contact with aggressive media
- Only replace complete sets
- Only use flexible elements of the same type and age

A.5.2 N-EUPEX flexible elements (12)

Table A-7 N-EUPEX flexible elements

Material	Hardness	Comment	Marking	Ambient temperature	Approved for explosion group
NBR	80 Shore A	Standard	Black flexible elements with blue stripe	-30 °C to +80 °C	IIA, IIB, IIC
NBR	65 Shore A	Special, soft, shifting of the resonant speed, rated torque reduced	Black flexible elements with green stripe	-30 °C to +80 °C	IIA, IIB, IIC
NBR	90 Shore A	Special, hard, shifting of the resonant speed	Black flexible elements with magenta stripe	-30 °C to +80 °C	IIA, IIB, IIC
NBR	80 Shore A	Special, increased (low-backlash)	Black flexible elements with yellow stripe	-30 °C to +80 °C	IIA, IIB, IIC
NBR	65 Shore A	Special, increased (low-backlash) shifting of the resonant speed, rated torque reduced	Black flexible elements with white stripe	-30 °C to +80 °C	IIA, IIB, IIC
NR	80 Shore A	Special, low-temperature use	Black flexible elements with orange stripe	-50 °C to +50 °C	IIA, IIB, IIC
HNBR	80 Shore A	Special, high-temperature use	Black flexible elements with red stripe	-10 °C to +100 °C	Not approved
NBR	80 Shore A	Special, electrically insulating	Green flexible elements	-30 °C to +80 °C	IIA, IIB

Quality documents

B.1 EU declaration of conformity

EU declaration of conformity

Product:

FLENDER N-EUPEX® Couplings
Types D, E and M

Name and address of the manufacturer:

Flender GmbH
Schlavenhorst 100
46395 Bocholt
Deutschland – Germany

This declaration of conformity is issued under the sole responsibility of the manufacturer.

This declaration refers to the product mentioned above.

The object of the declaration described above is in conformity with the relevant legislation of the Union:

– Directive 2014/34/EU Official Journal L 96, 29.3.2014, Pages 309-356

Harmonised standards or other technical specifications on which the declaration of conformity is based:

EN 1127-1	: 2011
EN ISO 80079-36	: 2016
EN ISO 80079-37	: 2016
EN ISO 80079-38	: 2017

The notified body, DEKRA EXAM GmbH, code number 0158, has received the technical documentation.

Signed for and on behalf of:
Flender GmbH

Bocholt, 2019-01-01



Dr. Tim Sadek, Vice President, Applications Couplings

FLENDER COUPLINGS

N-EUPEX

Operating Instructions 3102en

Edition 01/2019

Flender GmbH

Alfred-Flender-Straße 77

46395 Bocholt

GERMANY

flender.com

FLENDER
A Siemens Company