

FLENDER COUPLINGS

RUPEX

Operating Instructions 3600en
Edition 01/2019

RWN, RWS, RFN, RFS



FLENDER COUPLINGS

RUPEX 3600en

Operating Instructions

RWN, RWS, RFN, RFS

<u>Introduction</u>	1
<u>Safety instructions</u>	2
<u>Description</u>	3
<u>Application planning</u>	4
<u>Assembly</u>	5
<u>Commissioning</u>	6
<u>Operation</u>	7
<u>Servicing</u>	8
<u>Service and support</u>	9
<u>Disposal</u>	10
<u>Spare parts</u>	11
<u>Technical data</u>	A
<u>Quality documents</u>	B

Legal information

Warning notice system

This manual contains notices you have to observe in order to ensure your personal safety, as well as to prevent damage to property. The notices referring to your personal safety are highlighted in the manual by a safety alert symbol, notices referring only to property damage have no safety alert symbol. These notices shown below are graded according to the degree of danger.

 DANGER
indicates that death or severe personal injury will result if proper precautions are not taken.

 WARNING
indicates that death or severe personal injury may result if proper precautions are not taken.

 CAUTION
indicates that minor personal injury can result if proper precautions are not taken.

NOTICE
indicates that property damage can result if proper precautions are not taken.

If more than one degree of danger is present, the warning notice representing the highest degree of danger will be used. A notice warning of injury to persons with a safety alert symbol may also include a warning relating to property damage.

Qualified Personnel

The product/system described in this documentation may be operated only by **personnel qualified** for the specific task in accordance with the relevant documentation, in particular its warning notices and safety instructions. Qualified personnel are those who, based on their training and experience, are capable of identifying risks and avoiding potential hazards when working with these products/systems.

Proper use of Flender products

Note the following:

 WARNING
Flender products may only be used for the applications described in the catalog and in the relevant technical documentation. If products and components from other manufacturers are used, these must be recommended or approved by Flender. Proper transport, storage, installation, assembly, commissioning, operation and maintenance are required to ensure that the products operate safely and without any problems. The permissible ambient conditions must be complied with. The information in the relevant documentation must be observed.

Trademarks

All names identified by ® are registered trademarks of Flender GmbH. The remaining trademarks in this publication may be trademarks whose use by third parties for their own purposes could violate the rights of the owner.

Disclaimer of Liability

We have reviewed the contents of this publication to ensure consistency with the hardware and software described. Since variance cannot be precluded entirely, we cannot guarantee full consistency. However, the information in this publication is reviewed regularly and any necessary corrections are included in subsequent editions.

Table of contents

1	Introduction	9
1.1	About these instructions	9
1.2	Text attributes	9
1.3	Copyright	9
2	Safety instructions	11
2.1	General information	11
2.2	Intended use	13
2.3	Safety instructions for a coupling for use in potentially explosive atmospheres	13
2.3.1	Marking	13
2.3.2	Conditions of use	14
2.4	General warning notices	15
3	Description	17
4	Application planning	19
4.1	Transport of the coupling	19
4.2	Storage of the coupling	19
5	Assembly	21
5.1	Preparatory work	21
5.1.1	Milling the parallel keyway	22
5.1.2	Milling the parallel keyway	23
5.1.3	Machining an axial locking mechanism	23
5.1.4	Balancing the coupling	25
5.2	Assembling the coupling	27
5.2.1	Assembling coupling parts with shaft and hub connected by a parallel key	27
5.2.2	Assembling coupling parts with shaft and hub connected by a pressurised oil interference fit	28
5.2.3	Assembling the coupling part 20 (20) with types RFN and RFS	29
5.3	Aligning the coupling	29
5.3.1	Purpose of alignment	29
5.3.2	Possible misalignment	30
5.3.2.1	Axial misalignment	30
5.3.2.2	Angular misalignment	30
5.3.2.3	Radial misalignment	31
6	Commissioning	33
7	Operation	35
7.1	Normal operation of the coupling	35
7.2	Faults - causes and rectification	35

7.2.1	Procedure in the event of malfunctions	35
7.2.2	Identifying the fault cause	35
7.2.2.1	Possible faults	36
7.2.2.2	Possible causes	37
7.2.3	Correcting faults	38
7.2.3.1	Replacing wearing parts.....	38
7.2.3.2	Correcting the changed alignment	39
8	Servicing.....	41
8.1	Maintenance intervals	41
8.2	Maximum permissible torsional backlash.....	42
8.3	Replacing wearing parts.....	43
8.3.1	Replacing buffers (5) up to coupling size 400	43
8.3.2	Replacing buffers (5) as of coupling size 450 to 630	44
8.3.3	Replacing buffers (5) as of coupling size 710	44
8.3.3.1	Replacing buffers (5) without removing the bolts (4).....	45
8.3.3.2	Replacing buffers (5) with removal of the bolts (4).....	45
8.3.4	Pressing out bolts.....	46
8.3.4.1	Pressing out bolts (4) with the "demounting box".....	46
8.3.4.2	Pressing out bolts (4) with grease	46
8.3.4.3	Potential problems when pressing out bolts (4) with grease	47
8.4	Removing coupling part 1 (1), 2 (2) or 20 (20)	47
8.4.1	Removing coupling part 1 (1) or 2 (2) with shaft and hub connected by a parallel key.....	48
8.4.2	Removing coupling part 1 (1) or 2 (2) with shaft and hub connected by a pressurised oil interference fit	48
8.4.3	Removing coupling part 20 (20) with flange connection	50
9	Service and support.....	53
10	Disposal.....	55
11	Spare parts	57
11.1	Ordering spare parts	57
11.2	Spare parts drawing and spare parts list.....	58
11.2.1	Types RWN and RWS	58
11.2.2	Types RFN and RFS.....	60
A	Technical data	63
A.1	Speeds, geometry data and weights.....	63
A.1.1	Types RWN and RWS	63
A.1.2	Types RFN and RFS.....	67
A.2	Shaft misalignment values during operation	70
A.3	Tightening torques and widths A/F.....	71
A.4	Tightening procedure	72
A.5	Buffers (5)	73
A.5.1	Use and storage of the buffers (5)	73
A.5.2	RUPEX buffers (5)	73

B	Quality documents.....	75
B.1	EU declaration of conformity	75

Tables

Table 2-1	General warnings	11
Table 2-2	Temperature classes (TX) for explosive atmospheres as a result of gases, vapours or mists.....	15
Table 2-3	Maximum surface temperature (TX) for an explosive atmosphere as a result of dust/air mixtures.....	15
Table 4-1	Types of preservative agents for long-term storage.....	20
Table 5-1	Recommended assigned fits for bores with parallel key connection.....	22
Table 5-2	Tapped hole, tightening torque and width A/F for types RWN and RFN.....	24
Table 5-3	Tapped hole, tightening torque and width A/F for types RWS and RFS	24
Table 5-4	Position of the tapped hole with respect to the parallel keyway	25
Table 7-1	Table of faults.....	36
Table 8-1	Maintenance intervals	41
Table 8-2	Maximum permissible torsional backlash for the types RWN, RWS and RFN, RFS (sizes 105 - 500).....	42
Table 8-3	Maximum permissible torsional backlash for the types RWN, RWS and RFN, RFS (sizes 560 - 2 000).....	42
Table 11-1	Spare parts list for types RWN and RWS.....	59
Table 11-2	Spare parts list for types RFN and RFS	60
Table A-1	Speeds, geometry data and weights of type RWN.....	63
Table A-2	Speeds, geometry data and weights of type RWS.....	65
Table A-3	Speeds, geometry data and weights of type RFN.....	68
Table A-4	Speeds, geometry data and weights of type RFS	69
Table A-5	Maximum permissible shaft misalignment values during operation	70
Table A-6	Tightening torques and widths A/F of bolt connection.....	71
Table A-7	Tightening torques for fastening coupling part 20 to the mating part	72
Table A-8	Tightening procedure	72
Table A-9	RUPEX buffers	73

Figures

Figure 3-1	Types RWN, RWS, RFN and RFS	17
Figure 3-2	Bolt connection.....	18
Figure 4-1	Transport symbols.....	19
Figure 5-1	Tolerances for the finished bore in coupling part 1 (1) or 2 (2)	23
Figure 5-2	Position of the balancing bore for single-plane balancing	26
Figure 5-3	Position of the balancing bore for two-plane balancing.....	26

Figure 5-4	Possible misalignment.....	30
Figure 8-1	Markings for calculating the torsional backlash.....	42
Figure 11-1	Spare parts drawing for types RWN and RWS	58
Figure 11-2	Screw plug.....	59
Figure 11-3	Spare parts drawing for types RFN and RFS.....	60
Figure 11-4	Screw plug.....	61
Figure A-1	Types RWN and RWS.....	63
Figure A-2	Types RFN and RFS	67

Introduction

1.1 About these instructions

These instructions describe the coupling and provide information about its handling - from assembly to maintenance. Please keep these instructions for later use.

Please read these instructions prior to handling the coupling and follow the information in them.

1.2 Text attributes

The warning notice system is explained on the back of the inner cover. Always follow the safety information and notices in these instructions.

In addition to the warning notices, which have to be observed without fail, you will find the following text attributes in these instructions:

1. Procedural instructions are shown as a numbered list. Always perform the steps in the order given.

- Lists are formatted as bulleted lists.
 - The dash is used for lists at the second level.

(1) Numbers in brackets are part numbers.

Note

A note is an important item of information about the product, the handling of the product or the relevant section of the instructions. The note provides you with help or further suggestions/ ideas.

1.3 Copyright

The copyright for these instructions is held by Flender.

These instructions must not be used wholly or in parts without our authorisation or be given to third parties.

If you have any technical queries, please contact our factory or one of our service outlets (refer to Service and support (Page 53)).

Safety instructions

2.1 General information

Instructions

These instructions are part of the delivery. Always keep these instructions close to the coupling.

Please make sure that every person who is commissioned to work on the coupling has read and understood these instructions prior to handling the coupling and observes all of the points.

Only the knowledge of these instructions can avoid faults on the coupling and ensure fault-free and safe operation. Non-adherence to the instructions can cause product or property damage or personal injury. Flender does not accept any liability for damage or operating failures that are due to non-adherence to these instructions.







State of the art

The coupling described here has been designed in consideration of the latest findings for demanding technical requirements. This coupling is state-of-the-art at the time of printing these instructions.





In the interest of further development, Flender reserves the right to make such changes to the individual components and accessories that increase performance and safety whilst maintaining the essential features.

Symbols

Table 2-1 General warnings

ISO	ANSI	Warning
		Warning - hazardous electrical voltage
		Warning - explosive substances
	---	Warning - entanglement hazard
	---	Warning - hot surfaces
	---	Warning - substances that are harmful to health or are irritants

2.1 General information

ISO	ANSI	Warning
	---	Warning - corrosive substances
	---	Warning - suspended load
	---	Warning - hand injuries
		ATEX certification

Explanation regarding Machinery Directive 2006/42/EC

The couplings described here are “components” in accordance with the Machinery Directive and do not require a declaration of incorporation.

ATEX Directive

The term "ATEX Directive" used in these instructions stands for the harmonisation legislation of the European Union in compliance with the declaration of conformance for equipment and protective systems for correct use in hazardous zones.

Protective clothing

In addition to the generally prescribed personal protective equipment (safety shoes, overalls, helmet, etc.), also wear suitable safety gloves and safety goggles when handling the coupling.

Using the coupling

The relevant work safety and environmental protection regulations must be complied with at all times during transport, assembly, installation, dismantling, operation and maintenance of the coupling.

Only qualified personnel may operate, assemble, maintain and repair the coupling. Information about qualified personnel can be found in the legal notes at the beginning of these instructions.

If lifting gear or load suspension devices are used for transporting, these have to be suitable for the weight of the coupling.

If the coupling has visible damage, it may not be assembled or put into operation.

The coupling may only be operated in a suitable housing or with touch protection according to applicable standards. This also applies to test runs and rotational direction checks.

Work on the coupling

Only carry out work on the coupling when it is not in operation and is not under load.

Secure the drive unit against being switched on accidentally. Attach a notice to the switch stating clearly that work is being carried out on the coupling. Ensure that the entire unit is not under load.

2.2 Intended use

Only use the coupling according to the conditions specified in the service and delivery contract and the technical data in the annex. Deviating operating conditions are considered improper use. The user or owner of the machine or plant is solely liable for any resulting damage.

When using the coupling please specifically observe the following:

- Do not make any modifications to the coupling that go beyond the permissible machining described in these instructions. This also applies to touch protection facilities.
- Only use original spare parts from Flender. Flender only accepts liability for original spare parts from Flender.
Other spare parts are not tested and approved by Flender. Non-approved spare parts may possibly change the design characteristics of the coupling and thus impact active and/or passive safety.
Flender will accept no liability or warranty whatsoever for damage occurring as a result of the use of non-approved spare parts. The same applies to any accessories that were not supplied by Flender.

If you have any queries, please contact our customer service (see Service and support (Page 53)).

2.3 Safety instructions for a coupling for use in potentially explosive atmospheres





2.3.1 Marking

You can find a description of the coupling parts in chapter Description (Page 17).

A coupling designed in accordance with the ATEX Directive has a marking on the coupling parts.





Coupling part 1 (1) without electrically insulating buffers

One of the following markings is visible on the outer diameter of coupling part 1:

Flender GmbH		 II 2G Ex h IIC T6 ... T4 Gb X
D 46393 Bocholt		 II 2D Ex h IIIC T85 °C ... 110 °C Db X
RUPEX	<Year of manufacture>	 I M2 Ex h Mb X

Coupling part 1 with electrically insulating buffers

One of the following markings is visible on the outer diameter of coupling part 1:

Flender GmbH			II 2G Ex h IIB T6 ... T4 Gb X
D 46393 Bocholt			II 2D Ex h IIIC T85 °C ... 110 °C Db X
RUPEX	<Year of manufacture>		I M2 Ex h Mb X

Coupling part 2 (2) or 20 (20)

Coupling part 2 (2) or 20 (20) is stamped with  .

Undrilled or predrilled coupling

A coupling part with Ex marking, the letter "U" and the Flender order number has been delivered undrilled or predrilled.

Note

Undrilled or predrilled coupling with Ex marking

Flender only supplies an undrilled or predrilled coupling with Ex marking on the condition that the customer assumes the responsibility and liability for correct finishing work in a declaration of exemption.

2.3.2 Conditions of use

Note

Note also the material-dependent permissible ambient temperature of the buffers (5) in accordance with section RUPEX buffers (5) (Page 73).

A coupling designed in accordance with the ATEX Directive is suitable for the following conditions of use:

- Equipment group I
 - Category M2
- Equipment group II
 - Category 2 and 3
 - Group of substances G, zone 1 and 2
 - Group of substances D, zone 21 and 22
 - Explosion group IIA, IIB and IIC
 - Explosion group IIA and IIB when electrically insulating buffers are used

Conditions of use for products with TX marking

The maximum ambient temperature stated in the following tables applies to the temperature in the direct vicinity of the coupling and the temperature of adjacent components.

1. Gases, vapours or mists

Check the ambient temperature for use of the coupling in the relevant temperature class.

Table 2-2 Temperature classes (TX) for explosive atmospheres as a result of gases, vapours or mists

Max. ambient temperature	Temperature class
80 °C	T4
70 °C	T5
55 °C	T6

2. Dust/air mixtures

Check the ambient temperature.

Table 2-3 Maximum surface temperature (TX) for an explosive atmosphere as a result of dust/air mixtures

Max. ambient temperature	Max. surface temperature
80 °C	110 °C

Notes concerning operation of the coupling in potentially explosive atmospheres

- Only use the coupling underground in mines in potentially explosive atmospheres together with drive motors that can be switched off in the event of the formation of an explosive atmosphere.
- Earth machines that are connected via the coupling with a leakage resistance of less than $10^6 \Omega$.
- If you want to use a coated coupling in potentially explosive atmospheres, please note the requirements concerning the conductivity of the paint and the limitation on the paint layer thickness applied in accordance with EN 80079-36. No build-up of electrostatic charges is to be expected with a paint layer thickness of less than 200 μm .

2.4 General warning notices



DANGER

Danger due to bursting of the coupling

The coupling may burst if it is not used properly. There is a risk of fatal injury from flying fragments. Bursting of the coupling can lead to an explosion in potentially explosive atmospheres.

- Use the coupling for the purpose for which it is intended.



! DANGER

Risk of explosion when using coupling parts without Ex marking

Coupling parts without Ex marking have not been approved for use in potentially explosive atmospheres. These coupling parts can lead to an explosion during operation.

- Only use couplings with Ex marking in potentially explosive atmospheres.



! DANGER

Danger

Risk of injury due to the use of unsuitable and/or damaged components. The use of unsuitable and/or damaged components can lead to an explosion in potentially explosive atmospheres.

- Observe the information regarding conditions of use.



! DANGER

Danger of explosion

Improper operation of the coupling can lead to an explosion in potentially explosive atmospheres.

- Please observe the notes concerning operation of the coupling in potentially explosive atmospheres.



! DANGER

Danger from hot coupling parts

Risk of injury due to hot surfaces. Hot coupling parts can lead to an explosion in potentially explosive atmospheres.

- Wear suitable protective equipment (gloves, safety goggles).
- Ensure that the area is not at risk of explosion.



! WARNING

Risk of chemical burns due to chemical substances

There is a risk of chemical burns when handling aggressive cleaning agents.

- Please observe the manufacturer's information on how to handle cleaning agents and solvents.
- Wear suitable protective equipment (gloves, safety goggles).

! CAUTION

Physical injury

Risk of injury due to falling coupling parts.

- Secure the coupling parts to prevent them from falling.

Description

The RUPEX couplings described here are torsionally flexible, damping pin and bush couplings and are available in various types and sizes. The couplings can be used in accordance with the ATEX Directive in potentially explosive atmospheres if they have a CE marking.

These instructions describe the assembly and operation of a RUPEX coupling arranged horizontally with a shaft-hub connection made by a cylindrical or conical bore with parallel key or by a pressurised oil interference fit. Types RWN and RWS have two shaft-hub connections. Types RFN and RFS have one shaft-hub connection and a flange. Please consult Flender if you want to use a different type of installation.

Application

RUPEX couplings are designed for use in all kinds of machines. They are designed to withstand high torques and harsh operating conditions.

Design

The diagrams show the various types with their constituent parts and their part numbers.

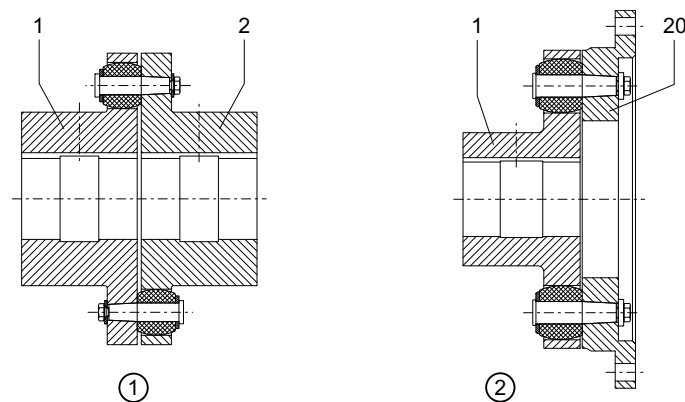

- ① Types RWN and RWS
- ② Types RFN and RFS
- 1 Coupling part 1
- 2 Coupling part 2
- 20 Coupling part 20

Figure 3-1 Types RWN, RWS, RFN and RFS

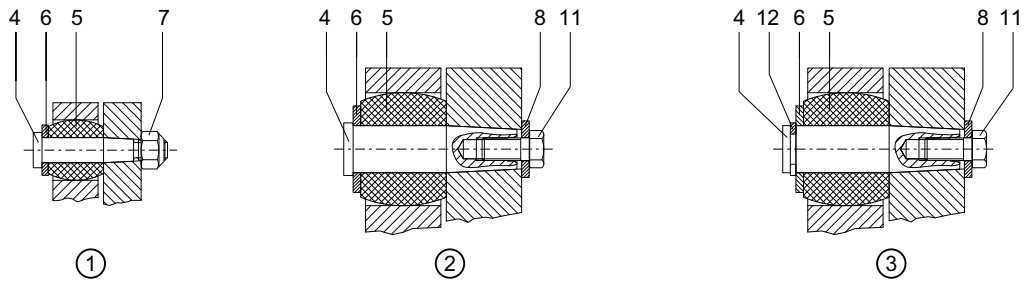

- ① Bolt connection for sizes 105 to 400
- ② Bolt connection for sizes 450 to 630
- ③ Bolt connection for sizes 710 to 2 000
- 4 Bolt
- 5 Buffer
- 6 Washer
- 7 Hexagon nut, self-locking
- 8 Washer
- 11 Hexagon head screw
- 12 Locking ring

Figure 3-2 Bolt connection

Application planning

Check the delivery for damage and for completeness. Report any damage and/or missing parts to Flender immediately.

The coupling is delivered in individual parts and preassembled groups. Preassembled groups may not be dismantled.

4.1 Transport of the coupling



<p>! WARNING</p> <p>Severe personal injury due to improper transport</p> <p>Severe personal injury due to falling components or due to crushing. Damage to coupling parts possible due to use of unsuitable transport means.</p> <ul style="list-style-type: none"> • Only use lifting gear and load suspension devices with sufficient load bearing capacity for transport. • Please observe the symbols applied on the packaging.

If not specifically contractually agreed otherwise, the packaging complies with the HPE Packaging Directive.

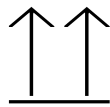

This way up



Fragile



Keep dry

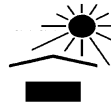

Keep dry

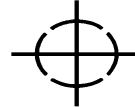

Centre of gravity



Do not use hand hook



Attach here

Figure 4-1 Transport symbols

4.2 Storage of the coupling

<p>NOTICE</p> <p>Property damage due to improper storage</p> <p>Negative changes to the physical properties of the coupling and/or coupling damage.</p> <ul style="list-style-type: none"> • Please observe the information about storing the coupling.
--

4.2 Storage of the coupling

The coupling, unless not specifically ordered otherwise, is supplied with preservation and can be stored for up to 3 months.

Note

Information about storing the coupling

- Ensure that the storage room is dry (relative humidity < 65 %) and free of dust.
- Ensure that there is no condensation.
- Do not store the coupling together with corrosive chemicals, acids, caustic solutions, etc.
- If the coupling contains elastomer components, ensure that there are no devices in the storage room that produce ozone, such as fluorescent lights, mercury vapour lamps or high-voltage electrical equipment.
- Store the coupling on suitable supports or in suitable containers.

Long-term storage

NOTICE

Property damage due to improper long-term storage

Negative changes to the physical properties of the coupling and/or coupling damage.

- Note the handling instructions for long-term storage.

1. You can find the required type of preservative agent in the following table (types of preservative agents for long-term storage).
2. Remove the elastomer components. These must not come into contact with cleaning agents and long-term preservative agents.
3. Clean the coupling parts.
4. Apply the stipulated preservative agent.
5. Store the coupling parts and the elastomer components separately.

Table 4-1 Types of preservative agents for long-term storage

Preservative agents	Features	Indoor storage	Outdoor storage
Oil spray	Anti-corrosion agent	Up to 12 months	Up to 4 months
Tectyl 846 or similar	Long-term preservative agent on wax basis	Up to 36 months	Up to 12 months
Emulsion cleaner + VCI foil	Active system, reusable	Up to 5 years	Up to 5 years

Assembly

Assembly of the coupling comprises the following steps:

- Preparatory work (Page 21)
- Assembling the coupling (Page 27)
- Aligning the coupling (Page 29)



! DANGER

Danger due to bursting of the coupling

If you do not observe the information stipulated here regarding assembly, this can lead to bursting of the coupling during operation. There is a risk of fatal injury from flying fragments. Bursting of the coupling can lead to an explosion in potentially explosive atmospheres.

- Please observe all the stipulations concerning assembly.

Note

Information about the assembly of the coupling

- Only use undamaged components for the assembly of the coupling.
- Follow the assembly sequence.
- Please ensure that there is sufficient space at the assembly location and that the location is tidy and clean in order to be able to assemble and maintain the coupling without any risk.
- If a dimension drawing has been created for the coupling, please observe the information it contains as a matter of priority.

5.1 Preparatory work

Note

Please consult Flender if you want to machine a conical finished bore.

Carry out the following steps if the coupling does not have a finished bore:

- Milling the parallel keyway (Page 22)
- Milling the parallel keyway (Page 23)
- Machining an axial locking mechanism (Page 23)
- Balancing the coupling (Page 25)

Note

The customer is responsible for execution of the finishing work on the coupling. Flender shall have no liability whatsoever for claims under warranty arising from finishing work that has not been carried out adequately.

5.1.1 Milling the parallel keyway

The diameter of the finished bore depends on the shaft used.

Recommended assigned fits

In the following table you can find the recommended assigned fits for bores with a parallel key connection. The assigned fit m6 / H7 is especially suitable for a host of applications.

Table 5-1 Recommended assigned fits for bores with parallel key connection

Description	Push fit		Press fit		Interference fit		
	Not suitable for reversing operation		Suitable for reversing operation				
Shaft tolerance	j6	h6	h6	k6	m6	n6	h6
Bore tolerance	H7	J7	K7	H7	H7	H7	M7

Procedure

1. Remove the bolts (4) and the buffers (5). For further information, refer to section Replacing wearing parts (Page 43).
2. Remove the preservation and clean the coupling parts 1 (1) and/or 2 (2) to be machined.

3. Clamp the coupling to the areas marked with  in the diagram below.
4. Machine the finished bore in accordance with the diagram below.

Note

Diameter of the finished bore

The diameter of the finished bore may not exceed the specified maximum diameter.

- Please observe the maximum diameters specified in section Speeds, geometry data and weights (Page 63).

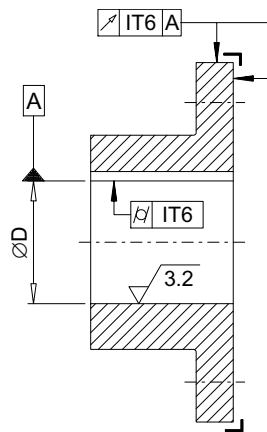

Figure 5-1 Tolerances for the finished bore in coupling part 1 (1) or 2 (2)

5.1.2 Milling the parallel keyway

Position of the parallel keyway

Arrange the parallel keyway in the centre between two adjacent buffer fitting holes or bolt fitting holes.

Applicable standards

- If the coupling is intended for use under normal operating conditions, mill the parallel keyway according to DIN 6885/1 ISO JS9.
- If the coupling is intended for reversing operation, mill the parallel keyway according to DIN 6885/1 ISO P9.
- If you want to mill a parallel keyway that does not correspond to DIN 6885/1, please consult Flender.

5.1.3 Machining an axial locking mechanism

The coupling part is secured by a set screw or an end plate to prevent axial movements.

Please consult Flender if you want to use an end plate.

Note the following when using a set screw:

- Diameter and axial position of the tapped hole in the hub
- Position of the tapped hole with respect to the parallel keyway
- Selection of the set screw

Diameter and axial position of the tapped hole in the hub

The axial position of the tapped hole is in the centre of the hub.

The following tables contain the values for the diameter of the tapped hole depending on the finished bore.

Table 5-2 Tapped hole, tightening torque and width A/F for types RWN and RFN

Finished bore		Tapped hole d_1	Tightening torque T_A Nm	Width across flats Hexagon socket wrench mm
over mm	up to mm			
8	30	M6	4	3
30	38	M8	8	4
38	65	M10	15	5
65	95	M12	25	6
95	110	M16	70	8
110	150	M20	130	10
150	230	M24	230	12
230	600	M30	470	14

Apply the recommended tightening torques in accordance with the stipulations in section Tightening procedure (Page 72).

Table 5-3 Tapped hole, tightening torque and width A/F for types RWS and RFS

Finished bore		Tapped hole d_1	Tightening torque T_A Nm	Width across flats Hexagon socket wrench mm
over mm	up to mm			
8	30	M6	4	3
30	75	M8	8	4
75	95	M12	25	6
95	110	M16	70	8
110	150	M20	130	10
150	230	M24	230	12
230	640	M30	470	14

Apply the recommended tightening torques in accordance with the stipulations in section Tightening procedure (Page 72).

Position of the tapped hole with respect to the parallel keyway

The tapped hole for the set screw is generally positioned on the parallel keyway. This does not apply to coupling parts of the sizes listed in the following table.

Table 5-4 Position of the tapped hole with respect to the parallel keyway

Size	Position of the tapped hole
105	Offset 180° relative to parallel keyway
125	Offset 180° relative to parallel keyway

Selection of the set screw

 CAUTION Physical injury Danger of injury from protruding set screw. <ul style="list-style-type: none"> • Please observe the information about selecting the set screw.

As set screws use threaded studs in accordance with ISO 4029 with a toothed cup point. The size of the set screw is determined by the bore made. The set screw should fill out the tapped hole as much as possible and must not protrude beyond the hub.

5.1.4 Balancing the coupling

Notes on balancing the coupling

NOTICE Damage to coupling part 1 (1), 2 (2) or 20 (20) If you completely drill through the flange on coupling part 1 (1), 2 (2) or 20 (20), then coupling part 1 (1), 2 (2) or 20 (20) is no longer allowed to be used for operation. <ul style="list-style-type: none"> • Please observe the stipulations about machining the balancing hole.

Please note the following when balancing the coupling:

- Select the balancing quality according to the application (but at least G16 in accordance with DIN ISO 21940).
- Observe the balancing specification according to DIN ISO 21940-32.
- Machine the balancing bore on a large radius with adequate clearance to the buffer fitting holes, the bolt fitting holes and the outer circumference.

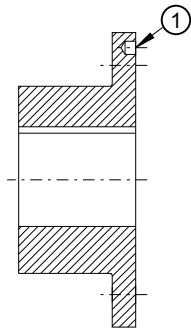

① Balancing bore

Figure 5-2 Position of the balancing bore for single-plane balancing

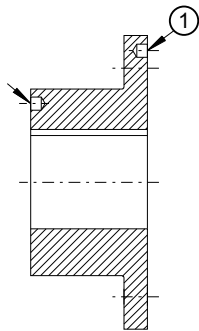

① Balancing bore

Figure 5-3 Position of the balancing bore for two-plane balancing

Note

A better balancing result can be achieved by balancing with bolt (4) fitted. When balancing with bolt (4) fitted, mark the bolt (4) and the bolt fitting hole.

5.2 Assembling the coupling

NOTICE
Property damage Damage to the elastomer components from cleaning agents. <ul style="list-style-type: none">• Ensure that the elastomer components do not come into contact with cleaning agents.

NOTICE
Property damage Damage to the shaft end, the coupling parts and/or the parallel key. <ul style="list-style-type: none">• Note the handling instructions regarding assembly of the coupling parts.

The procedure for assembling the coupling parts varies depending on the selected shaft-hub connection.

- Assembling coupling parts with shaft and hub connected by a parallel key (Page 27)
- Assembling coupling parts with shaft and hub connected by a pressurised oil interference fit (Page 28)
- Assembling the coupling part 20 (20) with types RFN and RFS (Page 29)

5.2.1 Assembling coupling parts with shaft and hub connected by a parallel key

Procedure

1. Unscrew the set screw out of coupling parts 1 (1) and/or 2 (2) until it is no longer possible for there to be a collision with the parallel key or the shaft.
2. Clean the bores and shaft ends.
3. Coat the bores of coupling parts 1 (1) and/or 2 (2) and the shafts with MoS₂ assembly paste (e.g. Microgleit LP 405).

4. Mount the coupling parts 1 (1) and/or 2 (2) on the shaft.

Note

Coupling parts with conical bore

Mount the coupling parts 1 (1) and/or 2 (2) with conical bore and parallel keyway on the shaft in cold condition. Secure the coupling parts with suitable end plates without pulling the coupling parts further onto the cone (fitting dimension = 0).

Note

Coupling parts with cylindrical bore

To make assembly easier, you can heat coupling parts 1 (1) and/or 2 (2) with cylindrical bore up to a maximum of 150 °C if required. Note when doing this the temperature range of the buffers (5) (see section RUPLEX buffers (5) (Page 73)). Remove the buffers (5) if necessary. For further information, refer to section Replacing wearing parts (Page 43). Protect adjacent components against damage and heating to temperatures above 80 °C.

5. Secure the coupling parts 1 (1) and/or 2 (2) with a set screw or an end plate. When securing with a set screw, the shaft must not protrude or be set back from the inner side of the hub.
6. Tighten up the set screw or the screw to attach the end plate to the specified tightening torque T_A (for the set screw please see section Machining an axial locking mechanism (Page 23)).
7. If you have removed the buffers (5), reinstall them. For further information, refer to section Replacing wearing parts (Page 43).

5.2.2 Assembling coupling parts with shaft and hub connected by a pressurised oil interference fit

Procedure

1. Remove the buffers (5). For further information, refer to section Replacing wearing parts (Page 43).
2. Remove the screw plugs (101) and/or (201) from the coupling parts 1 (1) and/or 2 (2).
3. Clean, degrease, de-oil and dry the bores and shaft ends.
4. Clean and dry the oil channels and the oil circulation grooves.
5. Protect adjacent components against damage and heating to temperatures above 80 °C.
6. Heat up the coupling parts 1 (1) and/or 2 (2) to the temperature specified in the dimension drawing.
Make sure that no dirt or contaminants can soil the bores again during the heating process.
7. Mount the coupling parts 1 (1) and/or 2 (2) quickly on the shaft according to the instructions in the dimension drawing.
8. Secure the coupling parts 1 (1) and/or 2 (2) to stop them from moving until they have cooled down.
9. Allow the coupling parts 1 (1) and/or 2 (2) to cool down to the ambient temperature.

10. Use an end plate to secure the coupling parts 1 (1) and/or 2 (2) that have a non-self-locking, tapered pressurised oil interference fit.
11. In order to protect the oil channels of the coupling parts 1 (1) and/or 2 (2) against corrosion, fill them with a suitable pressurised oil and seal the oil channels with the screw plugs (101) and/or (201).
12. Assemble the buffers (5). For further information, refer to section Replacing wearing parts (Page 43).

5.2.3 Assembling the coupling part 20 (20) with types RFN and RFS

Procedure

1. Clean the coupling part 20 (20).
2. Flange-mount the coupling part 20 (20) on the mating part.
3. Tighten the screws to the specified tightening torque T_A (see section Tightening torques and widths A/F (Page 71)).

5.3 Aligning the coupling

5.3.1 Purpose of alignment

The shafts that are joined by the coupling are never on an ideal precise axis but have a certain amount of misalignment.

Misalignment in the coupling leads to restoring forces that can stress adjacent machine parts (e.g. the bearings) to an unacceptable extent.

The misalignment values in operation result from the following:

- Misalignment due to assembly
Incorrect position due to a lack of precision when aligning
- Misalignment due to operation
Example: Load-related deformation, thermal expansion

You can minimise misalignment by aligning after assembly. A lower misalignment in the coupling has the following advantages:

- Reduced wear of the elastomer components
- Reduced restoring forces
- Misalignment reserves for operation of the coupling

You can find the maximum permitted shaft misalignment values during operation in section Shaft misalignment values during operation (Page 70).

5.3.2 Possible misalignment

The following types of misalignment can occur:

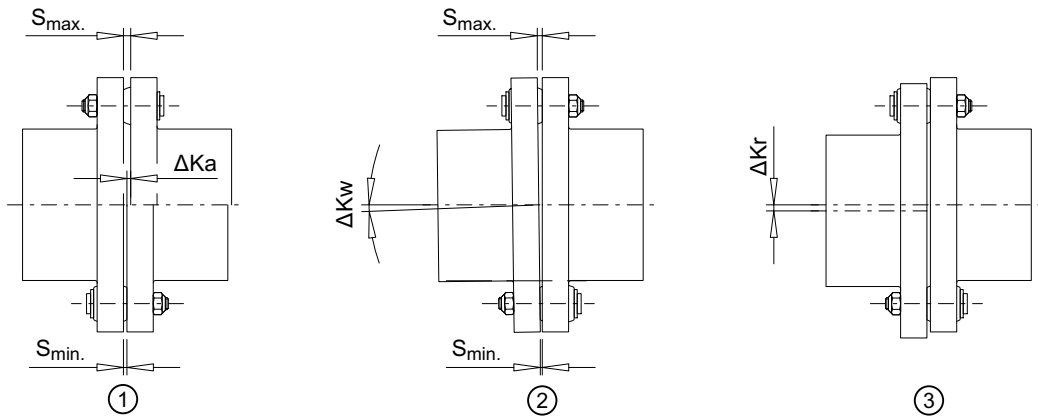

- ① Axial misalignment (ΔK_a)
- ② Angular misalignment (ΔK_w)
- ③ Radial misalignment (ΔK_r)

Figure 5-4 Possible misalignment

5.3.2.1 Axial misalignment

Set the axial misalignment ΔK_a to a value within the permissible tolerance range of dimension S.

You can find the values for dimension S in section Speeds, geometry data and weights (Page 63).

5.3.2.2 Angular misalignment

Determine the value ΔS ($\Delta S = S_{max} - S_{min}$). The determined value ΔS may not exceed the value ΔS_{perm} .

You can find the values for ΔS_{perm} in section Shaft misalignment values during operation (Page 70).

If required, you can calculate the angular misalignment ΔK_w as follows:

$$\Delta K_w \text{ [rad]} = \Delta S / DA$$

$$\Delta K_w \text{ [deg]} = (\Delta S / DA) \cdot (180 / \pi)$$

If required, you can calculate the permissible angular misalignment $\Delta K_{w,perm}$ as follows:

$$\Delta K_{w,perm} \text{ [rad]} = \Delta S_{perm} / DA$$

$$\Delta K_{w,perm} \text{ [deg]} = (\Delta S_{perm} / DA) \cdot (180 / \pi)$$

DA in mm see section Speeds, geometry data and weights (Page 63)

ΔS_{perm} see section Shaft misalignment values during operation (Page 70)

5.3.2.3 Radial misalignment

Determine the value ΔK_r . The determined value ΔK_r may not exceed the value $\Delta K_{r_{perm}}$.

You can find the permissible radial misalignment $\Delta K_{r_{perm}}$ in section Shaft misalignment values during operation (Page 70).



! DANGER

Danger due to igniting deposits

During use in potentially explosive atmospheres deposits from heavy metal oxides (rust) can ignite due to friction, impact or friction sparks and lead to an explosion.

- Ensure through the use of an enclosure or other suitable measures that the deposition of heavy metal oxides (rust) on the coupling is not possible.

In order to ensure safe commissioning, carry out various tests prior to commissioning.

Testing before commissioning



! DANGER

Danger

Overload conditions can occur during the commissioning of the coupling. The coupling can burst and metal parts can be flung out. There is a risk of fatal injury from flying fragments. Bursting of the coupling can lead to an explosion in potentially explosive atmospheres.

- Carry out the tests prior to commissioning.
- Do not touch the rotating coupling.

1. Check the tightening torques of the screws of the coupling in accordance with section Tightening torques and widths A/F (Page 71).
2. Check the tightening torques of the foundation bolts of the coupled machines.
3. Check whether suitable enclosures (ignition protection, coupling guard, touch protection) have been installed and that the function of the coupling has not been adversely affected by the enclosure. This also applies to test runs and rotational direction checks.

Operation

7.1 Normal operation of the coupling

The coupling runs quietly and shock-free during normal operation.

7.2 Faults - causes and rectification

A form of behaviour which is different to normal operation is classed as a fault and has to be rectified immediately.

Look out specifically for the following faults during coupling operation:

- Unusual coupling noise
- Sudden occurrence of shocks

7.2.1 Procedure in the event of malfunctions



! DANGER

Danger due to bursting of the coupling

There is a risk of fatal injury from flying fragments. Bursting of the coupling can lead to an explosion in potentially explosive atmospheres.

- Switch off the unit at once if any malfunctions occur.
- Note during the maintenance work the possible causes of faults and the notes on rectifying them.

Proceed as described below if there is a malfunction of the coupling during operation:

1. De-energise the drive immediately.
2. Initiate the required action for repair, taking into consideration the applicable safety regulations.

If you cannot determine the cause or if you cannot carry out repair work with your own means, request one of our customer service technicians.

7.2.2 Identifying the fault cause

Faults occur frequently due to application errors or they occur due to operational circumstances such as wear of wearing parts or changes to the system.

The faults and fault causes listed below only serve as an indication for troubleshooting. In the case of a complex system be sure to include all the system components in the search for the fault.



	WARNING
Physical injury	
Injury from rotating parts.	
<ul style="list-style-type: none"> • Only carry out work on the coupling when it is not moving. • Secure the drive unit against being operated accidentally. • Attach a notice to the switch stating clearly that work is being carried out on the coupling. • Before starting any work, make sure that the unit is free from loads. 	

Intended use

The coupling is only approved for the applications specified in these instructions. Please observe all the stipulations in section Intended use (Page 13).

7.2.2.1 Possible faults

Table 7-1 Table of faults

Fault	Cause	Rectification
Sudden changes in the noise level and/or sudden occurrences of shocks	Wear of wearing parts	Follow the instructions given in section Replacing wearing parts (Page 38).
	Changed alignment	Follow the instructions given in section Correcting the changed alignment (Page 39).
	Coupling not suitable for the operating conditions. Check the possible causes given in section Unsuitable coupling (Page 37).	Use a coupling that is suitable for the operating conditions.
	Incorrect assembly of the coupling. Check the possible causes given in sections Assembly-related causes (Page 37) and Specific installation-related and maintenance-related causes (Page 38).	Reassemble the coupling in accordance with these instructions. Please observe all the stipulations and requirements given in chapter Assembly (Page 21).
	Incorrect maintenance of the coupling. Check the possible causes given in sections Maintenance-related causes (Page 38) and Specific installation-related and maintenance-related causes (Page 38).	Please observe all the stipulations and requirements given in chapter Servicing (Page 41).

Fault	Cause	Rectification
Presence of vibration	Coupling not suitable for the operating conditions. Check the possible causes given in section Unsuitable coupling (Page 37).	Use a coupling that is suitable for the operating conditions.
	Incorrect assembly of the coupling. Check the possible causes given in sections Assembly-related causes (Page 37) and Specific installation-related and maintenance-related causes (Page 38).	Reassemble the coupling in accordance with these instructions. Please observe all the stipulations and requirements given in chapter Assembly (Page 21).
	Incorrect maintenance of the coupling. Check the possible causes given in sections Maintenance-related causes (Page 38) and Specific installation-related and maintenance-related causes (Page 38).	Please observe all the stipulations and requirements given in chapter Servicing (Page 41).

7.2.2.2 Possible causes

Unsuitable coupling

- Important information on the description of the drive unit and the environment were not available when the coupling was chosen.
- System torque too high and/or torque dynamics not permissible.
- System speed too high.
- Application factor not selected correctly.
- Chemically aggressive environment not taken into consideration.
- Coupling not suitable for the ambient temperature.
- Diameter and/or assigned fit of the finished bore not permissible.
- Width across corners of the parallel keyways greater than the width across corners of the parallel keyways in accordance with DIN 6885/1 for the maximum permissible bore.
- Shaft-hub connection incorrectly sized.
- Maximum permissible load conditions not taken into consideration.
- Maximum permissible overload conditions not taken into consideration.
- Dynamic load conditions not taken into consideration.
- Coupling and the machine and/or drive train form a critical torsional, axial or bending vibration system.

Assembly-related causes

- Damaged parts installed.
- Shaft diameter outside the stipulated tolerance range.

- Coupling parts interchanged and hence not assigned to the specified shaft.
- Stipulated locking elements to prevent axial movements not installed.
- Stipulated tightening torques not adhered to.
- Bolts inserted dry or greased.
- Flange surfaces of screwed connections not cleaned.
- Alignment and/or shaft misalignment values not set in accordance with the instructions.
- Coupled machines were not correctly connected to the foundation so that a shifting of the machines leads to an impermissible displacement of the coupling parts.
- Coupled machines not earthed adequately.
- Coupling guard used is not suitable.

Maintenance-related causes

- Stipulated maintenance intervals not adhered to.
- Spare parts that were used were not original spare parts from Flender.
- Flender spare parts that were used were old or damaged.
- Leak in the area of the coupling not detected so that chemically aggressive substances damage the coupling.
- Indications of faults, such as noise or vibration, were not heeded.
- Stipulated tightening torques not adhered to.
- Alignment and/or shaft misalignment values not set in accordance with the instructions.

Specific installation-related and maintenance-related causes

- Buffers (5) not fitted.
- Fitted buffers (5) heated up excessively when applying heat to the coupling parts.
- Buffers (5) of different types or age are used.
- Buffers (5) not replaced as sets.

7.2.3 Correcting faults

7.2.3.1 Replacing wearing parts

Buffers (5) are subject to wear and this wear can result in torsional backlash.

Procedure

1. Check the wear on the buffers (5) (see section Maximum permissible torsional backlash (Page 42)).
2. Replace the buffers (5) where appropriate (see section Replacing wearing parts (Page 43)).

7.2.3.2 Correcting the changed alignment

A changed alignment of the coupling during operation often occurs when the coupled machines shift towards one another. A cause of this can be loose foundation bolts.

Procedure

1. Correct the cause for the change in alignment.
2. Check the wearing parts for wear and replace them as required.
3. Check the locking elements that prevent axial movements and correct these as required.
4. Realign the coupling.

8.1 Maintenance intervals



 DANGER
<p>Danger due to bursting of the coupling</p> <p>The coupling can burst if the maintenance intervals are not adhered to. There is a risk of fatal injury from flying fragments. Bursting of the coupling can lead to an explosion in potentially explosive atmospheres.</p> <ul style="list-style-type: none"> • Please observe all the stipulations concerning maintenance of the coupling in this section.



 DANGER
<p>Danger due to bursting of the coupling</p> <p>The coupling can burst if the maximum permitted torsional backlash is exceeded. There is a risk of fatal injury from flying fragments. Bursting of the coupling can lead to an explosion in potentially explosive atmospheres.</p> <ul style="list-style-type: none"> • Note also the actual wear of the elastomer components.



 WARNING
<p>Physical injury</p> <p>Injury from rotating parts.</p> <ul style="list-style-type: none"> • Only carry out work on the coupling when it is not moving. • Secure the drive unit against being operated accidentally. • Attach a notice to the switch stating clearly that work is being carried out on the coupling. • Before starting any work, make sure that the unit is free from loads.

Check the torsional backlash between the coupling parts at the specified maintenance intervals. The maximum permissible torsional backlash for the various coupling sizes can be found in section Maximum permissible torsional backlash (Page 42).

Table 8-1 Maintenance intervals

Type	Initial maintenance	Follow-up maintenance
RWN	3 months after commissioning	Every 12 months
RWS		
RFN		
RFS		

Note

Shorter maintenance intervals

If necessary, set shorter maintenance intervals depending on actual wear.

8.2 Maximum permissible torsional backlash

In order to calculate the torsional backlash, rotate one coupling part without applying torque up to the stop. Mark both of the coupling halves in the way shown in the diagram below. Turn the coupling part in the opposite direction up to the stop. The markings on both halves will then move apart. The distance between the markings corresponds to the torsional backlash.

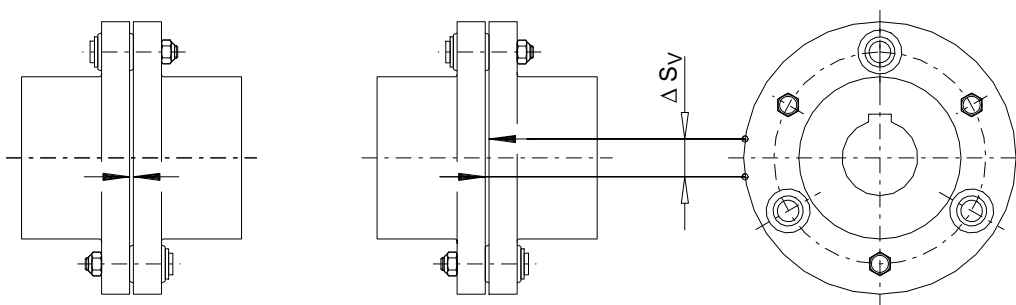

Figure 8-1 Markings for calculating the torsional backlash

Table 8-2 Maximum permissible torsional backlash for the types RWN, RWS and RFN, RFS (sizes 105 - 500)

Size	105	125 144	162 198	228 252	285 320	360 400	450 500
Maximum permissible torsional backlash ΔS_v [mm]	3.0	3.5	4.0	4.5	6.0	7.0	8.5

Table 8-3 Maximum permissible torsional backlash for the types RWN, RWS and RFN, RFS (sizes 560 - 2 000)

Size	560 630	710 800	900 1 000	1 120 1 250	1 400 1 600	1 800 2 000
Maximum permissible torsional backlash ΔS_v [mm]	10.0	12.0	13.5	15.0	18.0	20.0

8.3 Replacing wearing parts



DANGER

Danger due to bursting of the coupling

If you do not observe the information stipulated here regarding replacement of wearing parts, this can lead to bursting of the coupling during operation. There is a risk of fatal injury from flying fragments. Bursting of the coupling can lead to an explosion in potentially explosive atmospheres.

- Please observe all the stipulations concerning the replacement of wearing parts.

Replace the buffers (5) if the maximum permissible torsional backlash has been reached. The method used to replace the buffers (5) and remove the bolts (4) varies according to the coupling size.

- Up to coupling size 400
Replacing buffers (5) up to coupling size 400 (Page 43)
- From coupling size 450 to 630
Replacing buffers (5) as of coupling size 450 to 630 (Page 44)
- From coupling size 710
Replacing buffers (5) as of coupling size 710 (Page 44)

8.3.1 Replacing buffers (5) up to coupling size 400

Procedure

1. Remove the hexagon nuts (7).
2. Remove the bolts (4) with the washers (6) and the buffers (5) through the buffer fitting holes.
3. Pull the buffers (5) off the bolts (4).
4. Clean the bolts (4), the washers (6), the buffer fitting holes and the bolt fitting holes in the coupling parts 1 (1) and 2 (2) or 20 (20).
5. Mount new buffers (5) on the bolts (4).
Please observe the information in section Use and storage of the buffers (5) (Page 73) when replacing the buffers (5).
6. Insert the bolts (4) with the washers (6) and the buffers (5) through the buffer fitting holes into the bolt fitting holes. Observe any markings that might be provided.
7. Secure the bolts (4) with new hexagon nuts (7) of the same quality.
8. Tighten the hexagon nuts (7) to the specified tightening torque T_A (see section Tightening torques and widths A/F (Page 71)).

8.3.2 Replacing buffers (5) as of coupling size 450 to 630

NOTICE
Blockage of cross bore of bolts (4)
The liquid screw locking agent can seal the cross bore of the bolts (4). Pressing out the bolts (4) with grease then becomes difficult or completely impossible.
<ul style="list-style-type: none">• Apply only a small quantity of the liquid screw locking agent to the screws (11).

When removing the bolts (4), please observe the information in section Pressing out bolts (Page 46).

Procedure

1. Remove the hexagon head screws (11) and the washers (8).
2. Remove the bolts (4) with the buffers (5) through the buffer fitting holes.
3. Pull the buffers (5) off the bolts (4).
4. Clean the bolts (4), the washers (6), the buffer fitting holes and the bolt fitting holes in the coupling parts 1 (1) and 2 (2) or 20 (20).
5. Mount new buffers (5) on the bolts (4). Please observe the information in section Use and storage of the buffers (5) (Page 73) when replacing the buffers (5).
6. Insert the bolts (4) with the washers (6) and the buffers (5) through the buffer fitting holes into the bolt fitting holes. Observe any markings that might be provided.
7. Push the washers (8) onto the screws (11).
8. Apply a small quantity of liquid screw locking agent (e.g. Loctite 243 medium strength) to the screws (11).
9. Secure the bolts (4) with the screws (11) and washers (8).
10. Tighten the screws (11) to the specified tightening torque T_A (see section Tightening torques and widths A/F (Page 71)).

8.3.3 Replacing buffers (5) as of coupling size 710

You can use the following methods to replace the buffers (5) on couplings of size 710 or larger.

- Replacing buffers (5) without removing the bolts (4) (Page 45)
- Replacing buffers (5) with removal of the bolts (4) (Page 45)

8.3.3.1 Replacing buffers (5) without removing the bolts (4)

Procedure

1. Remove the locking rings (12) and the washers (6).
2. Pull out the buffers (5) through the buffer fitting holes.
3. Clean the bolts (4) and the buffer fitting holes in the coupling parts 1 (1) and 2 (2) or 20 (20).
4. Mount new buffers (5) on the bolts (4). Please observe the information in section Use and storage of the buffers (5) (Page 73) when replacing the buffers (5).
5. Secure the buffers (5) with the washers (6) and the locking rings (12).

8.3.3.2 Replacing buffers (5) with removal of the bolts (4)

NOTICE

Blockage of cross bore of bolts (4)

The liquid screw locking agent can seal the cross bore of the bolts (4). Pressing out the bolts (4) with grease then becomes difficult or completely impossible.

- Apply only a small quantity of the liquid screw locking agent to the screws (11).

Procedure

1. Remove the bolts (4). Please observe the relevant information in section Pressing out bolts (Page 46).
2. Remove the locking rings (12) and the washers (6).
3. Pull the buffers (5) off the bolts (4).
4. Clean the bolts (4), the washers (6), the locking rings (12), the buffer fitting holes and the bolt fitting holes in the coupling parts 1 (1) and 2 (2) or 20 (20).
If old bolts (4) are to be reused, the tapped holes and cross bores must be completely free of any residues of grease or liquid screw locking agent.
5. Mount new buffers (5) on the bolts (4). Please observe the information in section Use and storage of the buffers (5) (Page 73) when replacing the buffers (5).
6. Secure the buffers (5) with the washers (6) and the locking rings (12).
7. Insert the bolts (4) with the buffers (5) into the bolt fitting holes. Observe any markings that might be provided.
8. Push the washers (8) onto the screws (11).
9. Apply a small quantity of liquid screw locking agent (e.g. Loctite 243 medium strength) to the screws (11).
10. Secure the bolts (4) with the screws (11) and washers (8).
11. Tighten the screws (11) to the specified tightening torque T_A (see section Tightening torques and widths A/F (Page 71)).

8.3.4 Pressing out bolts

The bolts (4) for coupling sizes 450 to 2 000 have cross bores that make it easier to press out the bolts (4).

8.3.4.1 Pressing out bolts (4) with the "demounting box"

Flender can supply a "demounting box" which is a hydraulic press-out fixture for removing bolts. Flender can supply the demounting box on request.

Note

Separate operating instructions

If you use the "demounting box" to remove the bolts (4), please observe the operating instructions BA 3600.1, "Demounting box for extraction of RUPEX bolts".

8.3.4.2 Pressing out bolts (4) with grease

 WARNING
Risk of injury from flying bolts (4) Loose bolts (4) can become detached from the coupling and fly through the air like a projectile. <ul style="list-style-type: none">• Secure the bolt axially by placing the washer (8) over screw (11) before you insert the screw (11) into the tapped hole of the bolt.



 WARNING
Risk of crush injuries as a result of bolt (4) suddenly working loose If bolt (4) suddenly works loose, the screw (11) and the washer (8) can be abruptly set in motion. <ul style="list-style-type: none">• While you are pressing out bolts, do not place your hands in the area around bolt (4), screw (11) or washer (8).

 WARNING
Risk of injury When you are pressing out the bolts (4), grease can escape under high pressure. If bolt (4) suddenly works loose, fragments can become detached and fly through the air at high speed. <ul style="list-style-type: none">• Wear safety goggles.

Procedure

1. Remove the hexagon head screws (11) and the washers (8).
2. Clean the tapped holes of the bolts (4) until they are free of all residues.

3. Fill the tapped hole of a bolt (4) to 90 % with commercially available machine grease (e.g. Fuchs Renolit H443-HD-88).
4. Wrap screw (11) in Teflon tape or Teflon sealing cord.
5. Place a washer (8) as an axial locking element over screw (11).
6. Insert the screw (11) with the washer (8) into the bolt (4) and tighten manually by two to three turns.
7. Using a spanner, continue turning the screw (11) slowly into the thread so that the grease is pressed evenly through the cross bore between the bolts (4) and the bolt fitting hole of the coupling part 1 (1) and 2 (2) or 20 (20).
The bolt (4) is released suddenly and makes a loud noise.
8. Repeat the process in the order specified for all the installed bolts (4).

8.3.4.3 Potential problems when pressing out bolts (4) with grease

Problem	Cause	Possible solutions
Bolt (4) is not released despite the fact that the screw is fully inserted.	Pressure is too low to release the bolt (4).	<ul style="list-style-type: none"> • Use a longer screw (11) (minimum strength class 8.8). • Fill more grease into the tapped hole of the bolt (4).
Bolts (4) are difficult or impossible to release.	Liquid locking agent for screws (11) has sealed the cross bore.	Clean the tapped hole and the cross bore of the bolt (4).
Grease is escaping. The bolt (4) is not released.	The tapped hole is not sufficiently sealed.	<ol style="list-style-type: none"> 1. Remove the screw (11). 2. Seal the screw (11) again in Teflon tape or Teflon sealing cord. 3. Press out the bolt (4) again with grease.

8.4 Removing coupling part 1 (1), 2 (2) or 20 (20)

The procedure to be followed depends on the existing shaft-hub connection or the flange connection:

- Removing coupling part 1 (1) or 2 (2) with shaft and hub connected by a parallel key (Page 48)
- Removing coupling part 1 (1) or 2 (2) with shaft and hub connected by a pressurised oil interference fit (Page 48)
- Removing coupling part 20 (20) with flange connection (Page 50)

8.4.1 Removing coupling part 1 (1) or 2 (2) with shaft and hub connected by a parallel key



! WARNING

Danger from burners and hot coupling parts

Risk of injury due to burners and hot surfaces. Burners or hot coupling parts can lead to an explosion in potentially explosive atmospheres.

- Wear suitable protective equipment (gloves, safety goggles).
- Ensure that the area is not at risk of explosion.

Procedure

1. Move the coupled machines apart.
2. Secure the coupling parts to prevent them from falling.
3. Remove the axial locking element (set screw, end plate).
4. Use a suitable pulling fixture.
5. Heat up the coupling part 1 (1) and/or 2 (2) using a burner above the parallel keyway along its length to maximum 80 °C.
Note when doing this the permissible temperature range of the buffers (5) (refer to section RUPLEX buffers (5) (Page 73)). Remove the buffers (5) if necessary.
6. Pull off the coupling part 1 (1) and/or 2 (2). Use suitable lifting gear when doing this.
7. Check the hub bore and the shaft for damage and protect them against corrosion.
8. Replace any damaged parts.

When reinstalling the coupling parts please observe the information in chapters Assembly (Page 21) and Commissioning (Page 33).

8.4.2 Removing coupling part 1 (1) or 2 (2) with shaft and hub connected by a pressurised oil interference fit



! DANGER

Oil pressure in excess of maximum permissible value

The coupling can burst. There is a risk of fatal injury from flying fragments. Bursting of the coupling can lead to an explosion in potentially explosive atmospheres.

- Do not exceed the maximum oil pressure specified in the dimension drawing.
- Keep the oil pressure constant in all oil channels during the entire procedure.



! DANGER

Danger as a result of improper handling of fixtures and pumps

Failure to handle fixtures and pumps properly can result in injuries. The coupling can burst. There is a risk of fatal injury from flying fragments. Bursting of the coupling can lead to an explosion in potentially explosive atmospheres.

- Please observe the manufacturer's information on handling the following tools:
 - Pulling fixtures
 - Pumps

! WARNING

Risk of injury as a result of coupling components or the pulling fixture working loose.

Coupling components or pulling fixtures can work loose and fall when dismantling work is in progress.

- Use suitable hoisting gear to hold the coupling part 1 (1) or 2 (2) and the pulling fixture in position.
- Attach an axial locking element if the pressurised oil interference fit is tapered.

Note

Leaking oil

1. When dismantling the coupling part, catch any oil which escapes.
2. Dispose of the oil according to the valid regulations.

Tools required

- One oil pump with pressure gauge (at least 2500 bar) per oil channel.
Or:
One motor-driven oil pump. One connection that can be closed independently is required for each oil channel.

Refer to the dimension drawing for the number of oil channels.

- With a stepped bore:
A motor-driven pump at the oil channel located at the point of transition from the smaller to the larger bore. A large quantity of oil per unit of time is needed here.
- Suitable connections and pipes.
- Suitable pulling fixture.
Or:
Retaining plate with retaining screws or threaded spindles with nuts. Material of the screws and spindles must have at least property class 10.9; material of the nuts depending on the material of the screws or spindles.
- Hydraulic cylinder with oil pump. Note displacement and pressure of the hydraulic cylinder. Refer to the dimension drawing for the required axial force.

Procedure

1. Move the coupled machines apart.
2. Remove the buffers (5). For further information, refer to section Replacing wearing parts (Page 43).
3. Use a suitable pulling fixture.
4. Secure the coupling part 1 (1) or 2 (2) and the pulling fixture in position to prevent them from falling.
5. Remove the screw plugs (101) or (201) from the oil channels.
6. Deaerate an oil pump and connect it to the oil channel in the centre.
7. Pressurise the oil pump to the pressure specified in the dimension drawing until oil starts to escape from the adjacent connections or the front faces. Keep the pressure constant.
8. Deaerate the next oil pump and connect it to the adjacent oil channel.
9. Repeat steps 7 and 8 on the remaining oil channels.
10. If so much oil escapes when pressure is applied that the pump cannot maintain the pressure, use a higher-viscosity oil.
11. Pressurise the hydraulic cylinder if oil escapes from both front faces as a closed oil ring. Make sure that the coupling part 1 (1) or 2 (2) is pulled immediately off the shaft in a swift, smooth movement.

Note

Removal in several strokes

If several strokes of the hydraulic cylinder are required to remove the part, make sure that the shaft end is positioned between two oil channels at the end of the stroke.

12. Dismantle the oil pumps and the pulling fixture from the coupling part 1 (1) or 2 (2) .
13. Check the hub bore and the shaft for damage and protect them against corrosion.
14. Replace any damaged parts.

When reinstalling the coupling parts please observe the information in chapters Assembly (Page 21) and Commissioning (Page 33).

8.4.3 Removing coupling part 20 (20) with flange connection

Procedure

1. Move the coupled machines apart.
2. Secure the coupling parts to prevent them from falling.
3. Remove the bolt connection from coupling part 20 (20) with the mating part and separate the components.
4. Check the coupling part 20 (20) for damage and protect it against corrosion.
5. Replace any damaged parts.

When reinstalling the coupling parts please observe the information in chapters Assembly (Page 21) and Commissioning (Page 33).

Service and support

Contact

When ordering spare parts, requesting a customer service technician or in the case of technical queries, please contact our factory or one of our customer service addresses:

Flender GmbH

Schlavenhorst 100

46395 Bocholt

Germany

Tel.: +49 (0)2871/92-0

Fax.: +49 (0)2871/92-2596

Flender GmbH (<http://www.flender.com>)

Disposal

Disposal of the coupling

Dispose of the coupling parts according to applicable national regulations or recycle them.

Spare parts

11.1 Ordering spare parts

By stocking the most important spare parts at the installation site you can ensure that the coupling is ready for use at any time.

Note**Original spare parts**

Only use original spare parts from Flender. Flender only accepts liability for original spare parts from Flender.

Other spare parts are not tested and approved by Flender. Non-approved spare parts may possibly change the design characteristics of the coupling and thus impact active and/or passive safety.

Flender will accept no liability or warranty whatsoever for damage occurring as a result of the use of non-approved spare parts. The same applies to any accessories that were not supplied by Flender.

You can find the available spare parts for the coupling described here at Spare parts drawing and spare parts list (Page 58).

You will find our contact data for ordering spare parts in Service and support (Page 53).

Information required when ordering spare parts

- Flender order number with item
- Flender drawing number
- Coupling type and size
- Part number (refer to Spare parts drawing and spare parts list (Page 58))
- Dimensions of the spare part, for example:
 - Bore
 - Bore tolerance
 - Parallel keyway and balancing
- Special dimensions, for example, flange connection dimensions, intermediate sleeve length or brake drum dimensions

- Any special properties of the spare part, such as, for example:
 - Temperature resistance
 - Electrical insulation
 - Operating fluid
 - Use in potentially explosive atmospheres
- Quantity

11.2 Spare parts drawing and spare parts list

11.2.1 Types RWN and RWS

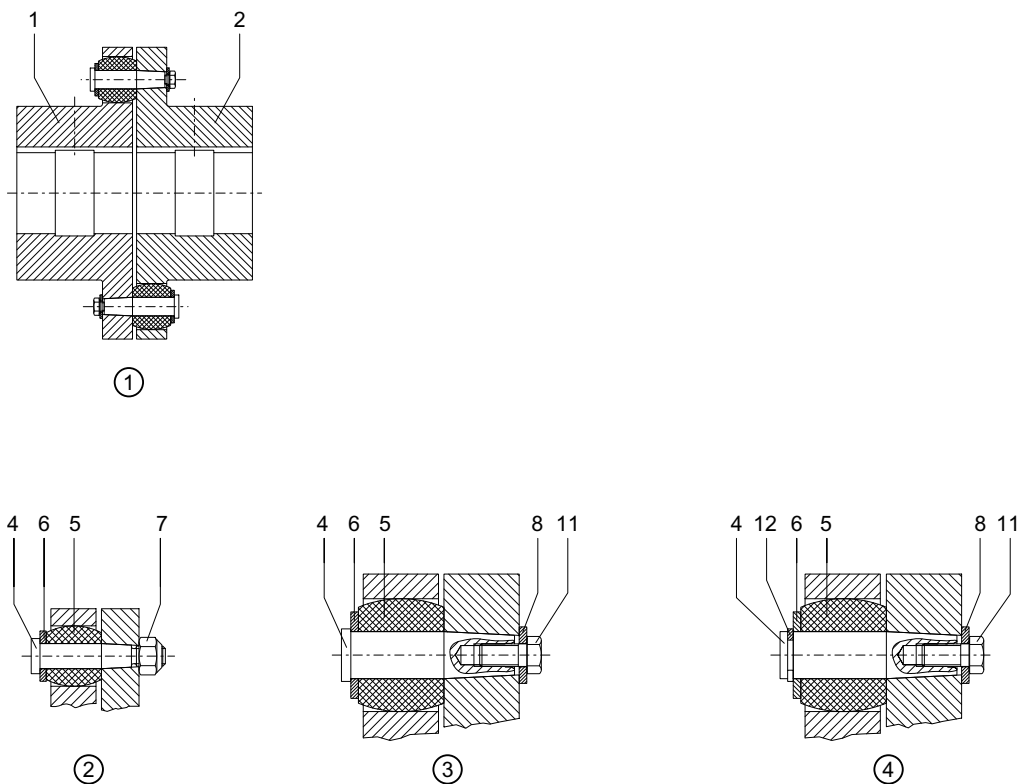

- ① Types RWN and RWS
- ② Bolt connection for sizes 105 to 400
- ③ Bolt connection for sizes 450 to 630
- ④ Bolt connection for sizes 710 to 2 000

Figure 11-1 Spare parts drawing for types RWN and RWS

Note**Arrangement of the buffers**

The buffers (5) are arranged on one side in the coupling part 1 (1) up to coupling size 360. With coupling size 400 or larger, the buffers (5) are arranged alternately in coupling part 1 (1) and coupling part 2 (2).

Table 11-1 Spare parts list for types RWN and RWS

Part number	Designation
1	Coupling part 1
2	Coupling part 2
4	Bolt
5	Buffer
6	Washer
7	Hexagon nut, self-locking
8	Washer
11	Hexagon head screw
12	Locking ring
101	Screw plug ¹⁾
201	Screw plug ¹⁾

¹⁾ Screw plugs (101, 201) are only used in combination with a pressurised oil interference fit.

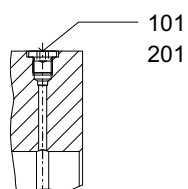
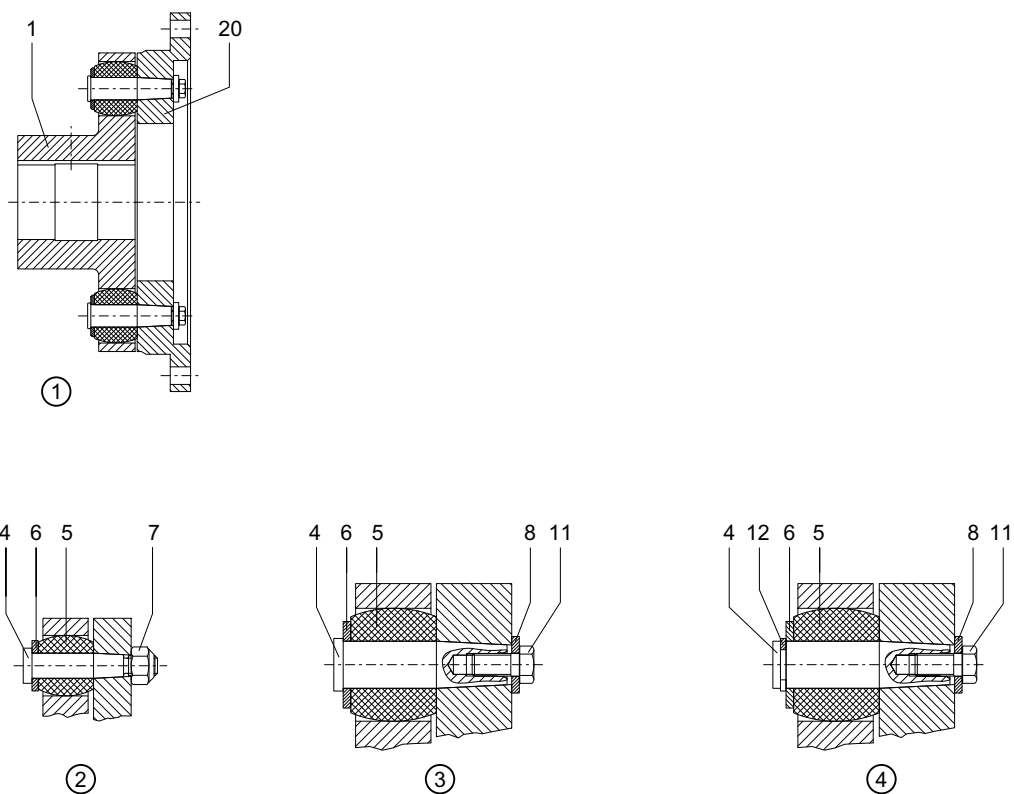

Figure 11-2 Screw plug

11.2.2 Types RFN and RFS



- ① Types RFN and RFS
- ② Bolt connection for sizes 105 to 400
- ③ Bolt connection for sizes 450 to 630
- ④ Bolt connection for sizes 710 to 800

Figure 11-3 Spare parts drawing for types RFN and RFS

Note

Arrangement of the buffers

The buffers (5) are arranged on one side in the coupling part 1 (1) up to coupling size 360. With coupling size 400 or larger, the buffers (5) are arranged alternately in coupling part 1 (1) and coupling part 20 (20).

Table 11-2 Spare parts list for types RFN and RFS

Part number	Designation
1	Coupling part 1
4	Bolt
5	Buffer
6	Washer
7	Hexagon nut, self-locking

Part number	Designation
8	Washer
11	Hexagon head screw
12	Locking ring
20	Coupling part 20
101	Screw plug ¹⁾

¹⁾ Screw plugs (101) are only used in combination with a pressurised oil interference fit.

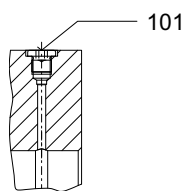

Figure 11-4 Screw plug

Spare parts

11.2 Spare parts drawing and spare parts list

Technical data

A.1 Speeds, geometry data and weights

In this section you can find dimension drawings and technical data for RUPEX couplings of the following types:

- Types RWN and RWS (Page 63)
- Types RFN and RFS (Page 67)

A.1.1 Types RWN and RWS

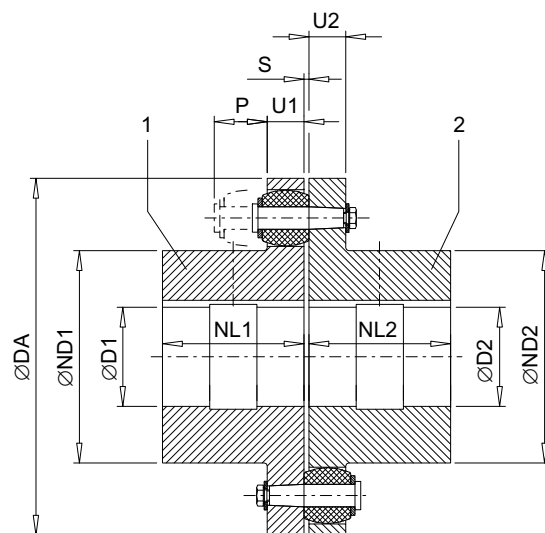

- 1 Coupling part 1
2 Coupling part 2

Figure A-1 Types RWN and RWS

Table A-1 Speeds, geometry data and weights of type RWN

Size	Speed n_{max} rpm	Maximum bore ¹⁾										Weight ²⁾ m kg
		D1	D2	DA	ND1	ND2	NL1	P	S	U1	U2	
		mm	mm	mm	mm	mm	mm	mm	mm	mm	mm	
105	7 000	32	38	105	53	59	45	30	2 ... 4	13	12	1.9
125	6 000	40	48	125	65	68	50	35	2 ... 4	16	15	3.2
144	5 250	45	55	144	76	84	55	35	2 ... 4	16	15	4.5
162	4 650	50	60	162	85	92	60	40	2 ... 5	20	18	6.7
178	4 200	60	70	178	102	108	70	40	2 ... 5	20	18	9.7

Technical data

A.1 Speeds, geometry data and weights

Size	Speed n_{\max} rpm	Maximum bore ¹⁾		DA	ND1	ND2	NL1 NL2	P	S	U1	U2	Weight ²⁾ m kg
		D1	D2									
		mm	mm									
198	3 750	70	80	198	120	128	80	40	2 ... 5	20	18	12.9
228	3 300	80	90	228	129	140	90	50	2 ... 5	26	24	19
252	3 000	90	100	252	150	160	100	50	2 ... 5	26	24	26.3
285	2 650	100	110	285	164	175	110	60	3 ... 6	32	30	39
320	2 350	110	120	320	180	192	125	60	3 ... 6	32	30	53
360	2 100	120	130	360	200	210	140	75	3 ... 6	42	42	78
400	2 050	140	140	400	230	230	160	75	3 ... 6	42	42	105
450	1 800	160	160	450	260	260	180	90	4 ... 7	52	52	156
500	1 600	180	180	500	290	290	200	90	4 ... 7	52	52	200
560	1 450	140	140	560	250	250	220	120	4 ... 8	68	68	280
		180	180		300	300						290
		200	200		320	320						295
630	1 280	140	140	630	250	250	240	120	4 ... 8	68	68	345
		180	180		300	300						370
		220	220		355	355						400
710	1 150	160	160	710	290	290	260	140	5 ... 9	80	80	510
		200	200		330	330						515
		240	240		385	385						540
800	1 000	180	180	800	320	320	290	140	5 ... 9	80	80	670
		220	220		360	360						690
		260	260		420	420						730
900	900	220	220	900	360	360	320	160	5 ... 10	90	90	940
		260	260		425	425						960
		290	290		465	465						1 030
1 000	810	240	240	1 000	395	395	350	160	5 ... 10	90	90	1 200
		280	280		460	460						1 250
		320	320		515	515						1 310
1 120	700	200	200	1 120	360	360	380	180	6 ... 11	100	100	1 470
		250	250		410	410						1 510
		300	300		495	495						1 600
		350	350		560	560						1 690
1 250	650	230	230	1 250	410	410	420	180	6 ... 11	100	100	1 850
		280	280		460	460						1 900
		330	330		540	540						2 025
		380	380		610	610						2 210
1 400	570	260	260	1 400	465	465	480	210	6 ... 12	120	120	2 820
		320	320		525	525						2 900
		380	380		620	620						3 180
		440	440		700	700						3 260

A.1 Speeds, geometry data and weights

Size	Speed n_{max} rpm	Maximum bore ¹⁾		DA	ND1	ND2	NL1 NL2	P	S	U1	U2	Weight ²⁾
		D1	D2									m
		mm	mm									kg
1 600	500	320	320	1 600	565	565	540	210	6 ... 12	120	120	3 780
		380	380		625	625						3 870
		440	440		720	720						4 150
		480	480		770	770						4 290
1 800	450	380	380	1 800	660	660	600	240	8 ... 16	140	140	5 550
		440	440		720	720						5 630
		500	500		820	820						6 000
		540	540		870	870						6 250
2 000	400	440	440	2 000	760	760	660	240	8 ... 16	140	140	6 800
		500	500		820	820						7 000
		560	560		920	920						7 350
		600	600		960	960						7 620

1) Maximum bore for parallel keyway in accordance with DIN 6885/1.

2) Weight applies to one coupling with maximum bore.

Table A-2 Speeds, geometry data and weights of type RWS

Size	Speed n_{max} rpm	Maximum bore ¹⁾		DA	ND1	ND2	NL1 NL2	P	S	U1	U2	Weight ²⁾
		D1	D2									m
		mm	mm									kg
105	10 000	32	38	105	53	59	45	30	2 ... 4	13	12	1.9
125	9 000	42	48	125	65	68	50	35	2 ... 4	16	15	3.2
144	7 800	50	60	144	76	84	55	35	2 ... 4	16	15	4.5
162	6 900	55	65	162	85	92	60	40	2 ... 5	20	18	6.7
178	6 300	70	75	178	102	108	70	40	2 ... 5	20	18	9.7
198	5 600	80	85	198	120	128	80	40	2 ... 5	20	18	12.9
228	4 900	85	95	228	129	140	90	50	2 ... 5	26	24	19
252	4 400	100	110	252	150	160	100	50	2 ... 5	26	24	26.3
285	3 900	110	120	285	164	175	110	60	3 ... 6	32	30	39
320	3 500	125	130	320	180	192	125	60	3 ... 6	32	30	53
360	3 100	135	140	360	200	210	140	75	3 ... 6	42	42	78
400	2 800	150	150	400	230	230	160	75	3 ... 6	42	42	110
450	2 500	170	170	450	260	260	180	90	4 ... 7	52	52	163
500	2 200	190	190	500	290	290	200	90	4 ... 7	52	52	217
560	2 000	165	165	560	250	250	220	120	4 ... 8	68	68	274
		200	200		300	300						292
		210	210		320	320						305

Technical data

A.1 Speeds, geometry data and weights

Size	Speed n _{max} rpm	Maximum bore ¹⁾		DA	ND1	ND2	NL1 NL2	P	S	U1	U2	Weight ²⁾ m kg
		D1	D2									
		mm	mm									
630	1 800	165	165	630	250	250	240	120	4 ... 8	68	68	352
		200	200		300	300						370
		235	235		355	355						400
710	1 600	190	190	710	290	290	260	140	5 ... 9	80	80	507
		220	220		330	330						530
		250	250		385	385						560
800	1 400	210	210	800	320	320	290	140	5 ... 9	80	80	683
		240	240		360	360						715
		280	280		420	420						762
900	1 250	210	210	900	320	320	320	160	5 ... 10	90	90	907
		240	240		360	360						933
		280	280		425	425						1 000
		310	310		465	465						1 025
1 000	1 100	230	230	1 000	355	355	350	160	5 ... 10	90	90	1 170
		260	260		395	395						1 208
		300	300		460	460						1 290
		340	340		515	515						1 343
1 120	1 000	240	240	1 120	360	360	380	180	6 ... 11	100	100	1 560
		270	270		410	410						1 660
		330	330		495	495						1 730
		370	370		560	560						1 870
1 250	900	270	270	1 250	410	410	420	180	6 ... 11	100	100	2 000
		300	300		460	460						2 150
		360	360		540	540						2 200
		400	400		610	610						2 420
1 400	800	310	310	1 400	465	465	480	210	6 ... 12	120	120	3 020
		350	350		525	525						3 120
		410	410		620	620						3 350
		460	460		700	700						3 570
1 600	700	370	370	1 600	565	565	540	210	6 ... 12	120	120	3 890
		410	410		625	625						4 270
		480	480		720	720						4 300
		510	510		770	770						4 630

Size	Speed n_{max}	Maximum bore ¹⁾		DA	ND1	ND2	NL1 NL2	P	S	U1	U2	Weight ²⁾ m kg
		D1	D2									
	rpm	mm	mm	mm	mm	mm	mm	mm	mm	mm	mm	kg
1 800	600	440	440	1 800	660	660	600	240	8 ... 16	140	140	6 230
		480	480		720	720						6 460
		540	540		820	820						6 770
		580	580		870	870						7 030
2 000	550	500	500	2 000	760	760	660	240	8 ... 16	140	140	8 140
		540	540		820	820						8 430
		610	610		920	920						8 860
		640	640		960	960						9 050

1) Maximum bore for parallel keyway in accordance with DIN 6885/1.

2) Weight applies to one coupling with maximum bore.

A.1.2 Types RFN and RFS

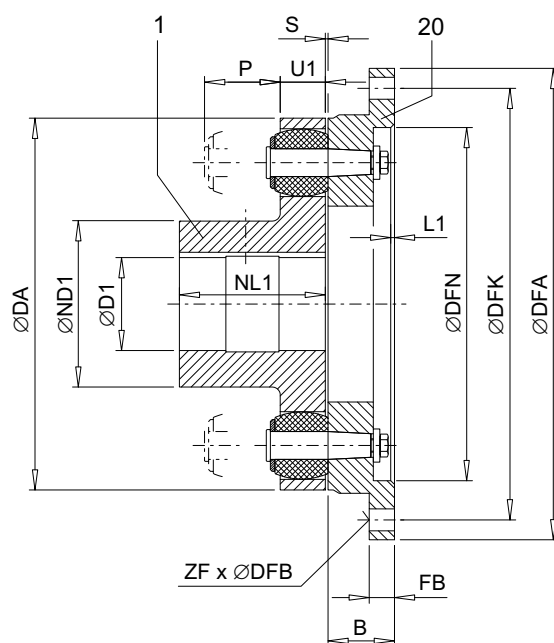

- 1 Coupling part 1
- 20 Coupling part 20

Figure A-2 Types RFN and RFS

Technical data

A.1 Speeds, geometry data and weights

Table A-3 Speeds, geometry data and weights of type RFN

Size	Speed n _{max.} rpm	Maximum bore ¹⁾															Weight ²⁾ m kg	
		D1	DA	ND1	NL1	P	S	U1	DFA	B	FB	DFN	L1	DFK	ZF	DFB		
		H7																
		mm	mm	mm	mm	mm	mm	mm	mm	mm	mm	mm	mm	mm	mm	mm	mm	mm
105	7 000	32	105	53	45	30	2 ... 4	13	158	23	10	-	-	142	6	9	2.3	
125	6 000	40	125	65	50	35	2 ... 4	16	180	28	13	-	-	160	6	11	4.2	
144	5 250	45	144	76	55	35	2 ... 4	16	200	28	13	-	-	180	7	11	5	
162	4 650	50	162	85	60	40	2 ... 5	20	220	34	13	-	-	200	8	11	7.3	
178	4 200	60	178	102	70	40	2 ... 5	20	248	34	16	-	-	224	8	14	10	
198	3 750	70	198	120	80	40	2 ... 5	20	274	34	16	-	-	250	8	14	13	
228	3 300	80	228	129	90	50	2 ... 5	26	314	42	20	-	-	282	8	18	20	
252	3 000	90	252	150	100	50	2 ... 5	26	344	42	20	-	-	312	8	18	25	
285	2 650	100	285	164	110	60	3 ... 6	32	380	51	22	-	-	348	9	18	38	
320	2 350	110	320	180	125	60	3 ... 6	32	430	51	25	-	-	390	9	22	50	
360	2 100	120	360	200	140	75	3 ... 6	42	480	66	25	-	-	440	10	22	76	
400	2 050	140	400	230	160	75	3 ... 6	42	520	70	50	380	4	480	10	22	125	
450	1 800	160	450	260	180	90	4 ... 7	52	575	80	45	428	6	528	12	26	170	
500	1 600	180	500	290	200	90	4 ... 7	52	620	80	45	475	6	570	12	26	205	
560	1 450	140	560	250	220	120	4 ... 8	68	700	100	65	532	8	650	16	26	330	
		180		300													330	
		200		320														340
630	1 280	140	630	250	240	120	4 ... 8	68	785	100	60	602	8	725	16	33	390	
		180		300														400
		220		355														420
710	1 150	160	710	290	260	140	5 ... 9	80	875	120	80	675	10	815	18	33	550	
		200		330														550
		240		385														570
800	1 000	180	800	320	290	140	5 ... 9	80	1000	120	70	765	10	930	16	39	680	
		220		360														690
		260		420														710

¹⁾ Maximum bore for parallel keyway in accordance with DIN 6885/1.

²⁾ Weight applies to one coupling with maximum bore.

Table A-4 Speeds, geometry data and weights of type RFS

Size	Speed n_{max} rpm	Maximum bore ¹⁾															Weight ²⁾ m kg
		D1	DA	ND1	NL1	P	S	U1	DFA	B	FB	DFN	L1	DFK	ZF	DFB	
H7																	
mm																	
105	10 000	32	105	53	45	30	2 ... 4	13	158	23	10	-	-	142	6	9	2.3
125	9 000	42	125	65	50	35	2 ... 4	16	180	28	13	-	-	160	6	11	4.2
144	7 800	50	144	76	55	35	2 ... 4	16	200	28	13	-	-	180	7	11	5
162	6 900	55	162	85	60	40	2 ... 5	20	220	34	13	-	-	200	8	11	7.3
178	6 300	70	178	102	70	40	2 ... 5	20	248	34	16	-	-	224	8	14	10
198	5 600	80	198	120	80	40	2 ... 5	20	274	34	16	-	-	250	8	14	13
228	4 900	85	228	129	90	50	2 ... 5	26	314	42	20	-	-	282	8	18	20
252	4 400	100	252	150	100	50	2 ... 5	26	344	42	20	-	-	312	8	18	25
285	3 900	110	285	164	110	60	3 ... 6	32	380	51	22	-	-	348	9	18	38
320	3 500	125	320	180	125	60	3 ... 6	32	430	51	25	-	-	390	9	22	50
360	3 100	135	360	200	140	75	3 ... 6	42	480	66	25	-	-	440	10	22	76
400	2 800	150	400	230	160	75	3 ... 6	42	520	70	50	380	4	480	10	22	125
450	2 500	170	450	260	180	90	4 ... 7	52	575	80	45	428	6	528	12	26	175
500	2 200	190	500	290	200	90	4 ... 7	52	620	80	45	475	6	570	12	26	210
560	2 000	165	560	250	220	120	4 ... 8	68	700	100	65	532	8	650	16	26	330
		200		300	340												
		210		320	340												
630	1 800	165	630	250	240	120	4 ... 8	68	785	100	60	602	8	725	16	33	390
		200		300	400												
		235		355	420												
710	1 600	190	710	290	260	140	5 ... 9	80	875	120	80	675	10	815	18	33	550
		220		330	560												
		250		385	580												
800	1 400	210	800	320	290	140	5 ... 9	80	1000	120	70	765	10	930	16	39	690
		240		360	710												
		280		420	730												

1) Maximum bore for parallel keyway in accordance with DIN 6885/1.

2) Weight applies to one coupling with maximum bore.

A.2 Shaft misalignment values during operation

The following table shows the maximum permissible shaft misalignment values ΔS_{perm} and $\Delta K r_{perm}$. The values are rounded and specified in mm.

Table A-5 Maximum permissible shaft misalignment values during operation

Size	Coupling speed in rpm								
	250	500	750	1 000	1 500	2 000	3 000	4 000	5 000
105	0.5	0.35	0.3	0.25	0.2	0.15	0.15	0.1	0.1
125	0.55	0.4	0.3	0.25	0.2	0.2	0.15	0.1	0.1
144	0.6	0.4	0.35	0.3	0.25	0.2	0.15	0.15	0.1
162	0.65	0.45	0.35	0.3	0.25	0.2	0.15	0.15	0.15
178	0.7	0.5	0.4	0.35	0.25	0.25	0.2	0.15	
198	0.75	0.5	0.4	0.35	0.3	0.25	0.2	0.15	
228	0.8	0.55	0.45	0.4	0.3	0.25	0.2	0.2	
252	0.85	0.6	0.5	0.45	0.35	0.3	0.25	0.2	
285	0.95	0.65	0.55	0.45	0.4	0.3	0.25		
320	1.05	0.75	0.6	0.5	0.4	0.35	0.3		
360	1.15	0.8	0.65	0.55	0.45	0.4	0.3		
400	1.25	0.85	0.7	0.6	0.5	0.45			
450	1.35	0.95	0.8	0.7	0.55	0.45			
500	1.5	1.05	0.85	0.75	0.6	0.5			
560	1.65	1.15	0.95	0.8	0.65	0.55			
630	1.85	1.3	1.05	0.9	0.75				
710	2.05	1.45	1.15	1	0.8				
800	2.25	1.6	1.3	1.1					
900	2.5	1.75	1.45	1.25					
1 000	2.75	1.95	1.6	1.35					
1 120	3.05	2.15	1.75	1.5					
1 250	3.4	2.4	1.95						
1 400	3.75	2.65	2.15						
1 600	4.3	3							
1 800	4.8	3.4							
2 000	5.3	3.75							

You can calculate the numerical values in the table and their intermediate values as follows:

$$\Delta K r_{perm} = \Delta S_{perm} = (0.1 + DA / 1000) \cdot 40 / \sqrt{n}$$

Coupling speed n in rpm
DA in mm (see Speeds, geometry data and weights (Page 63))
Radial misalignment $\Delta K r_{perm}$ in mm

The values in column "250 rpm" of the table above apply for speeds of < 250 rpm.

A.3 Tightening torques and widths A/F

Use bolts of strength class 8.8

Table A-6 Tightening torques and widths A/F of bolt connection

Size	Tightening torque	Width A/F external hexagon
	T _A Nm	SW mm
105	8	10
125	15	13
144	15	13
162	30	17
178	30	17
198	30	17
228	55	19
252	55	19
285	100	24
320	100	24
360	170	27
400	170	27
450	180	24
500	180	24
560	340	30
630	340	30
710	580	36
800	580	36
900	600	36
1 000	600	36
1 120	1 150	46
1 250	1 150	46
1 400	1 150	46
1 600	1 150	46
1 800	2 000	55
2 000	2 000	55

A.4 Tightening procedure

Apply the recommended tightening torques in accordance with the stipulations in section Tightening procedure (Page 72).

Table A-7 Tightening torques for fastening coupling part 20 to the mating part

Size	Bolt size	Tightening torque T _A Nm
105	M8	25
125	M10	49
144	M10	49
162	M10	49
178	M12	86
198	M12	86
228	M16	210
252	M16	210
285	M16	210
320	M20	410
360	M20	410
400	M20	410
450	M24	710
500	M24	710
560	M24	710
630	M30	1 450
710	M30	1 450
800	M36	2 530

Apply the recommended tightening torques in accordance with the stipulations in section Tightening procedure (Page 72).

A.4 Tightening procedure

Tighten fastening screws to the specified tightening torque in accordance with the following table:

Table A-8 Tightening procedure

Scatter of the torque applied at the tool	Tightening procedure (As a rule, the tightening procedures listed are within the specified tool torque scatter)
±5 %	<ul style="list-style-type: none"> Hydraulic tightening with mechanical screwdriver Torque-controlled tightening with a torque wrench or a torque wrench that gives a signal Tightening with a precision mechanical screwdriver with dynamic torque measurement

The tightening torques apply to screws/bolts with untreated surfaces that are not oiled or are only lightly oiled, and for screws/bolts that are used with a liquid screw locking agent in accordance with these instructions. Use with lubricant paint or lubricant is not permitted.

A.5 Buffers (5)

A.5.1 Use and storage of the buffers (5)

Note the following concerning the use and storage of the buffers (5):

- Storage possible for up to 5 years
- Protect against direct sunlight, artificial light with a high UV-content and extreme temperatures
- Avoid contact with aggressive media
- Only replace complete sets
- Only use buffers (5) of the same type and age

A.5.2 RUPEX buffers (5)

Table A-9 RUPEX buffers

Material	Hardness	Comment	Marking	Ambient temperature	Approved for explosion group
NBR	80 Shore A	Standard	Black buffer	-30 °C to +80 °C	IIA, IIB, IIC
NBR	65 Shore A	Special, soft, shifting of the resonant speed, rated torque reduced	Black buffer with green dot on front face	-30 °C to +80 °C	IIA, IIB, IIC
NBR	90 Shore A	Special, hard, shifting of the resonant speed	Black buffer with magenta dot on front face	-30 °C to +80 °C	IIA, IIB, IIC
NBR 639	80 Shore A	Special, electrically insulating	Green buffer	-30 °C to +80 °C	IIA, IIB
NR	80 Shore A	Special, low-temperature use	Black buffer with white dot on front face	-50 °C to +50 °C	IIA, IIB, IIC
HNBR	80 Shore A	Special, high-temperature use	Black buffer with red dot on front face	-10 °C to +100 °C	Not approved

Quality documents

B.1 EU declaration of conformity

EU declaration of conformity

Product:

FLENDER RUPEX® Couplings
Types RWN, RWS and RFN, RFS

Name and address of the manufacturer:

Flender GmbH
Schlavenhorst 100
46395 Bocholt
Deutschland – Germany

This declaration of conformity is issued under the sole responsibility of the manufacturer.

This declaration refers to the product mentioned above.

The object of the declaration described above is in conformity with the relevant legislation of the Union:

– Directive 2014/34/EU Official Journal L 96, 29.3.2014, Pages 309-356

Harmonised standards or other technical specifications on which the declaration of conformity is based:

EN 1127-1	: 2011
EN ISO 80079-36	: 2016
EN ISO 80079-37	: 2016
EN ISO 80079-38	: 2017

The notified body, DEKRA EXAM GmbH, code number 0158, has received the technical documentation.

Signed for and on behalf of:
Flender GmbH

Bocholt, 2019-01-01



Dr. Tim Sadek, Vice President, Applications Couplings

FLENDER COUPLINGS

RUPEX

Operating Instructions 3600en

Edition 01/2019

Flender GmbH

Alfred-Flender-Straße 77

46395 Bocholt

GERMANY

flender.com

FLENDER
A Siemens Company